

The sustainable ramp solution

PREASSEMBLED

# RAMP AND SHOWER SOLUTIONS

KIT PACKAGES COMES PREASSEMBLED AND  
READY TO INSTALL, EASY TO ADJUST IN HEIGHT  
FROM 18 - 199 MM

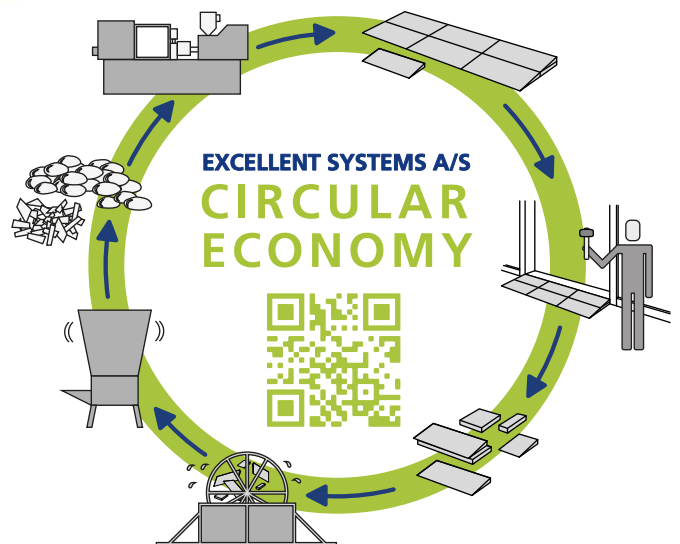
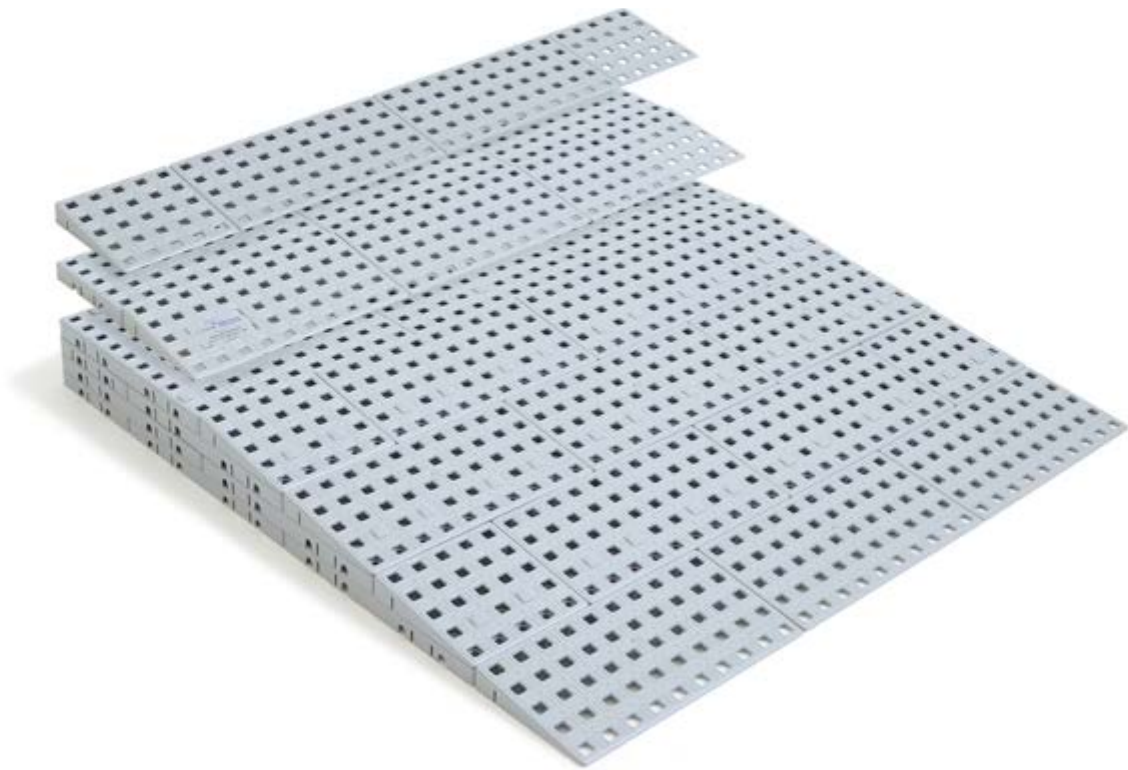

[excellent-kit.com](http://excellent-kit.com)

# KIT RAMP SYSTEM

---

The KIT system is easy to install and adjust in height. There are many ways of combining ramps, platforms and corners for the best access. Different surfaces are available for indoor and outdoor solutions.

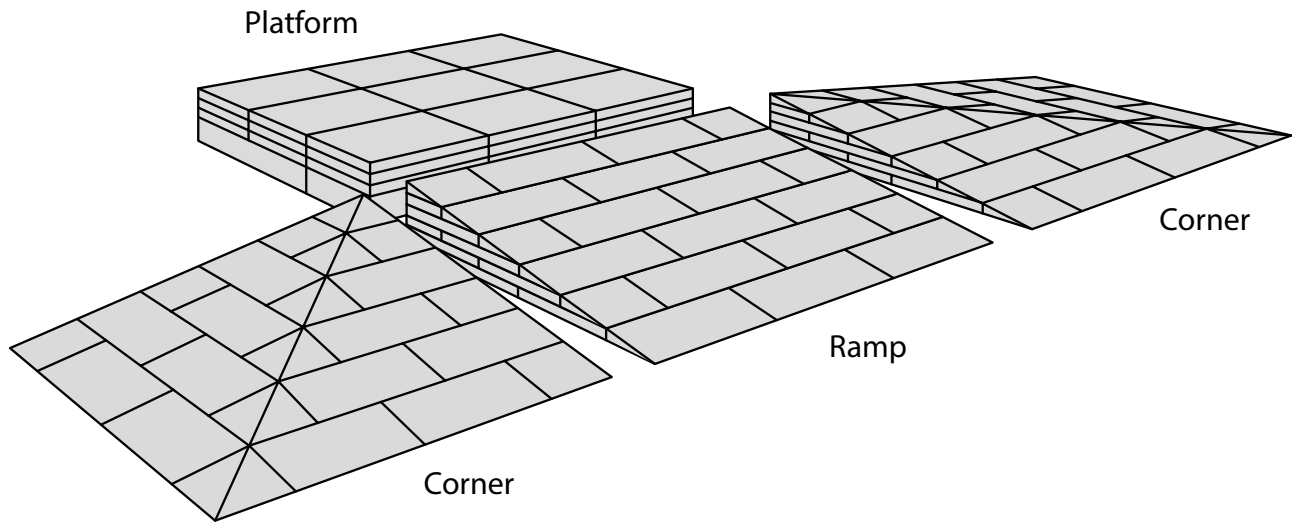

## Inspiration:

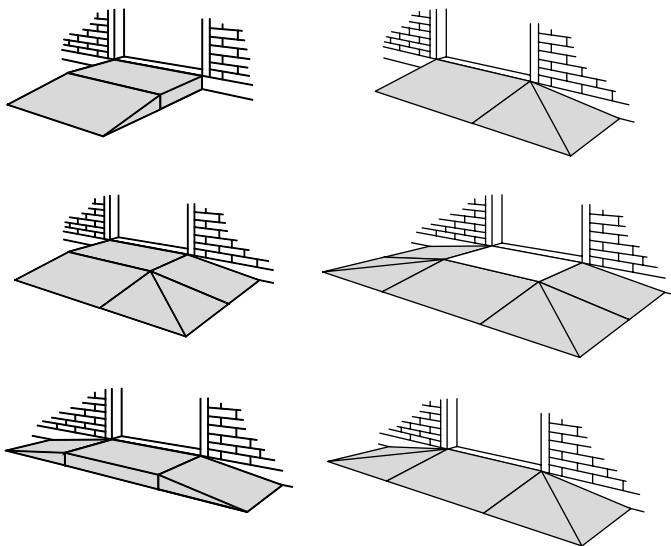

## Surfaces:

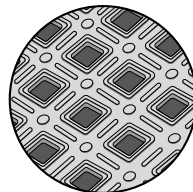

Surface: With holes  
Use: Indoor

Available for all KITs

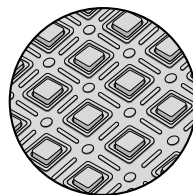

Surface: SlipStop  
Use: Outdoor

Available for all KITs

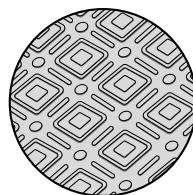

Surface: No holes  
Use: Indoor only

Available for Ramp KITs  
and Platforms

The two upper layers of the KITS are loose to make it possible to do the final adjustments in different locations and different kind of thresholds. Use the Ramp Adjuster to adjust the height.

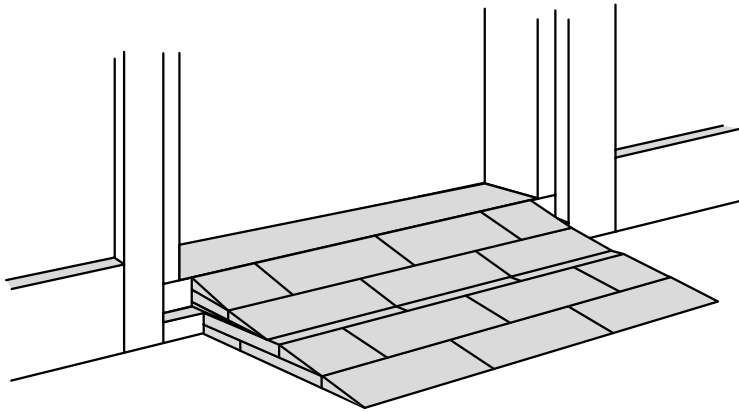

Different combinations of Ramp KITS on a threshold:

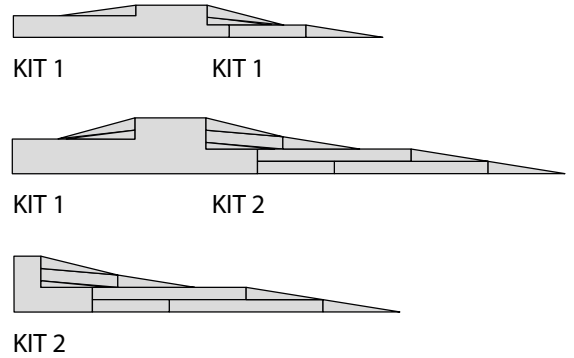

Sparepart packages:

**KIT Sparepart 1**  
Bag of 1 Ramp Adjuster

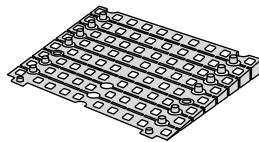

**KIT Sparepart 6**  
Bag of 10 C-Lock

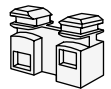

**KIT Sparepart 2**  
Bag of 1 Ramp Adjuster corner

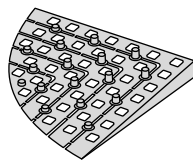

**KIT Sparepart 7**  
Bag of 1 Mounting Pad + Screw

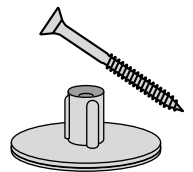

**KIT Sparepart 3**  
Bag of 10 R-Lock



**KIT Sparepart 8**  
Bag of 10 Stoppers



**KIT Sparepart 4**  
Bag of 10 T-Lock

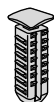

**KIT Sparepart 9**  
Bag of 3 Expansion Guides

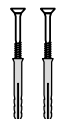

**KIT Sparepart 5**  
Bag of 10 S-Lock

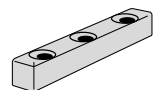
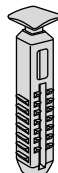

# RAMP KITS

KIT inclination: 1:7 (14%)

Width: 75 cm

Width: 100 cm

Measurements:

Instructions:

KIT 001

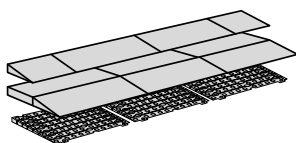

KIT 101

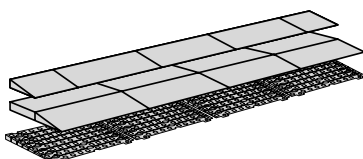

Height: 18-55 mm  
Depth: 25 cm



KIT 002

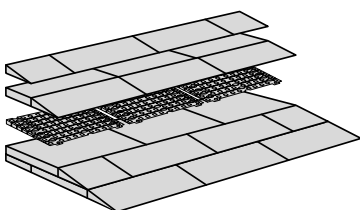

KIT 102

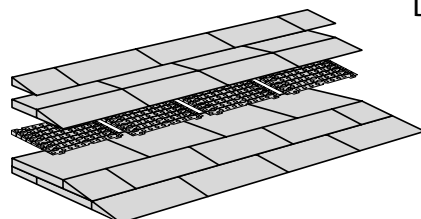

Height: 36-91 mm  
Depth: 50 cm



KIT 003

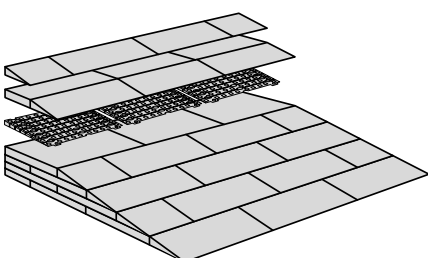

KIT 103

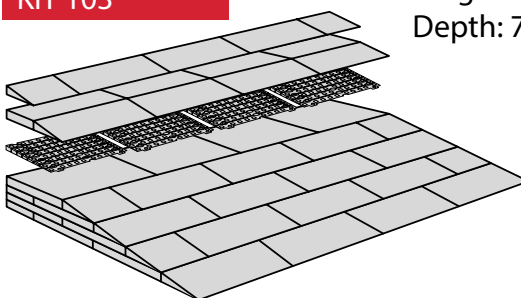

Height: 72-127 mm  
Depth: 75 cm



KIT 004

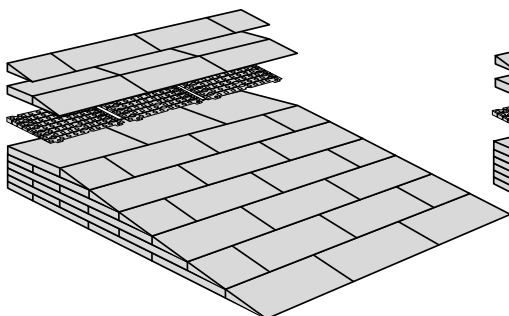

KIT 104

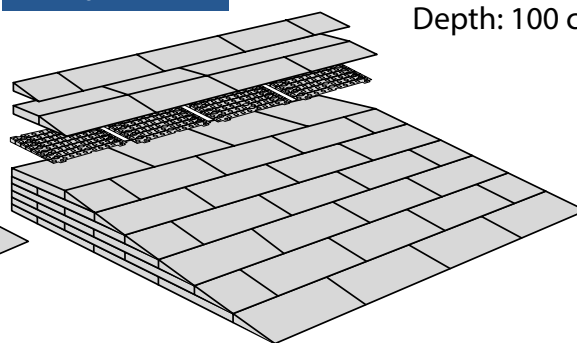

Height: 108-163 mm  
Depth: 100 cm



KIT 005

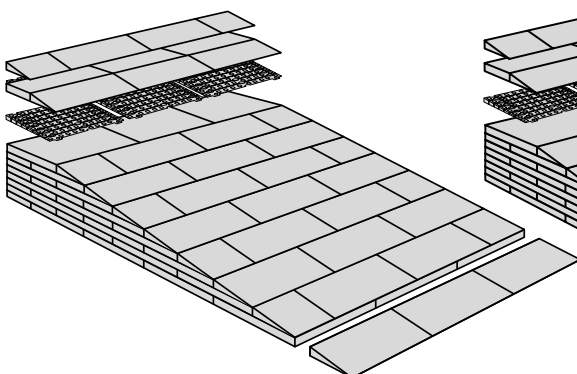

KIT 105

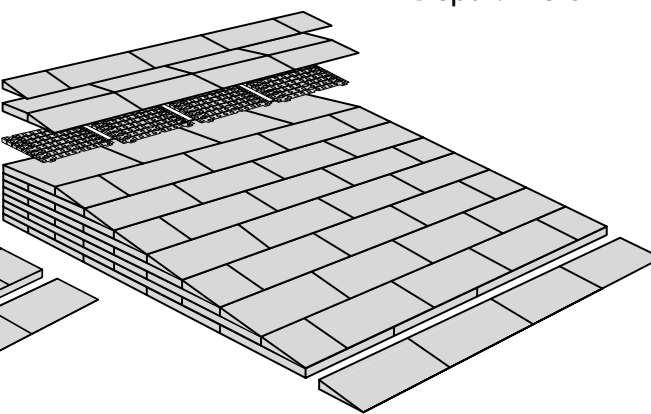

Height: 144-199 mm  
Depth: 125 cm



# PLATFORMS

# CORNERS

Width: 75 / 100 cm

Depth: 75 cm

KIT 1 / 101 Platform

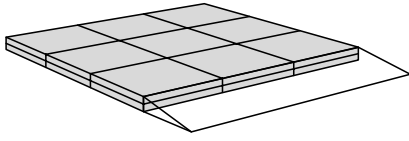

KIT 1 Corner

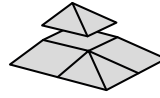

KIT 2 / 102 Platform

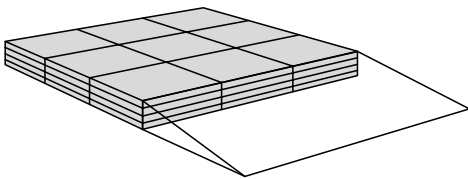

KIT 2 Corner

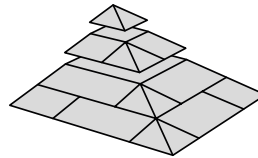

KIT 3 / 103 Platform

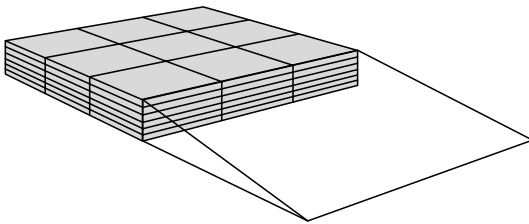

KIT 3 Corner

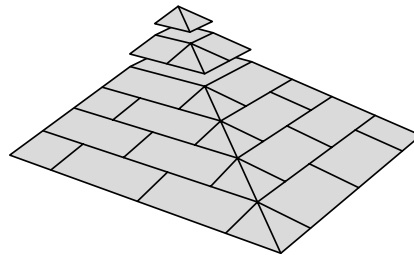

KIT 4 / 104 Platform

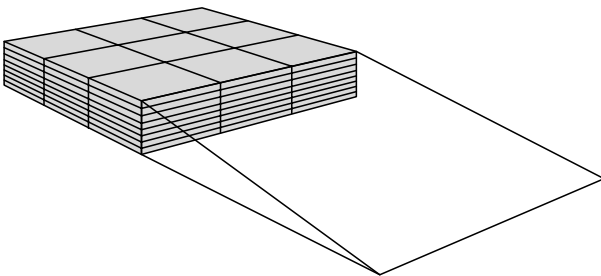

KIT 004 Corner

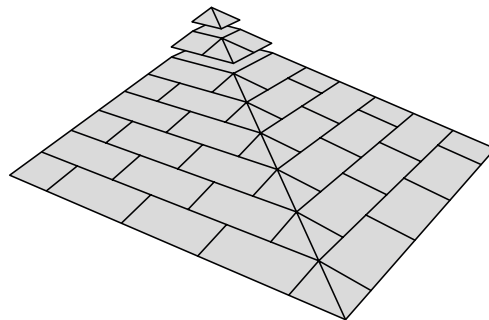

KIT 5 / 105 Platform

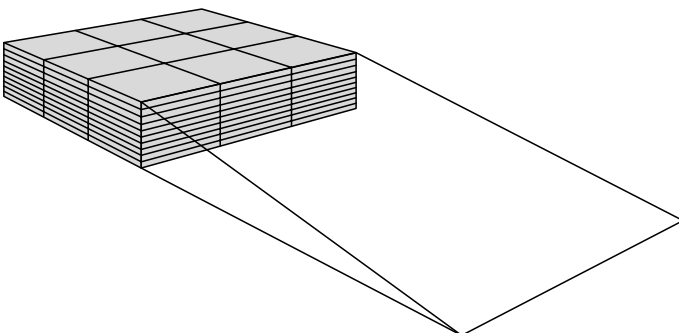

KIT 005 Corner

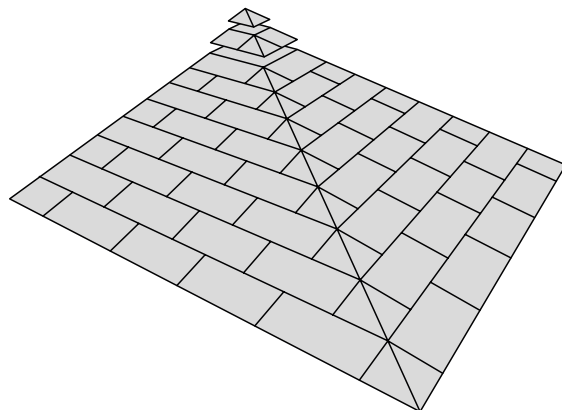

# SHOWER KITS

Getting in and out of the shower can represent a great obstacle for many people because of the need for either a raised edge or a recessed area to contain the water. This creates an obstacle, both for the user and for those assisting the user in the shower.

By using Excellent Systems well proven ramps and tiles, it is quick, easy and above all, affordable, to overcome these obstacles by leveling the floor to the correct height while maintaining slip resistance and water drainage through the holes in the tiles.

It is safe to use Shower KITS with heavy wheelchairs and shower commodes. You might also need our Ramp Kit to assist with the entrance into a shower area.

## How to use the shower KITS

Use Shower KIT 1 if the recessed area fits the height of one tile.

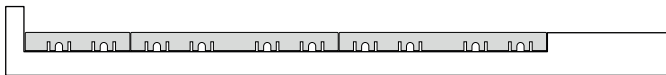

Edge to the floor 18 mm

Use Shower KIT 2 or 3, if the shower recess area is more than 2 mm lower than the tiles or tray edge.

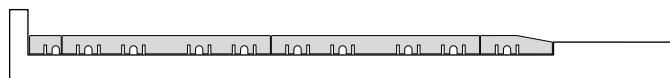

Edge to the floor 12 mm

Use KIT 3 if the edge is more than 18 mm and you need two layers of tiles.

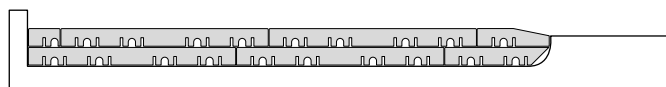

Edge to the floor 30 mm

## Shower KIT 1

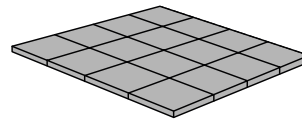

16 tiles 100x100 cm

## Shower KIT 2

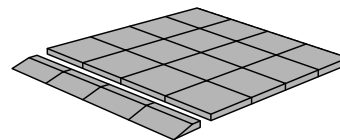

16 tiles 100x100 cm  
and 4 ramps

## Shower KIT 3

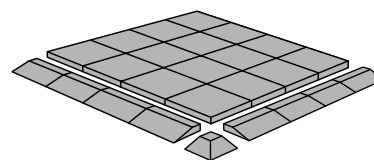

16 tiles 100x100 cm  
8 ramps  
1 corner ramp

## Shower KIT examples

Shower KIT 1

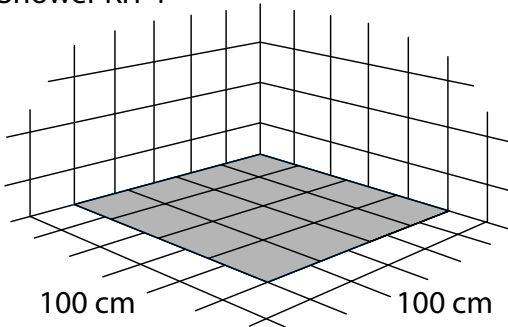

Shower KIT 2

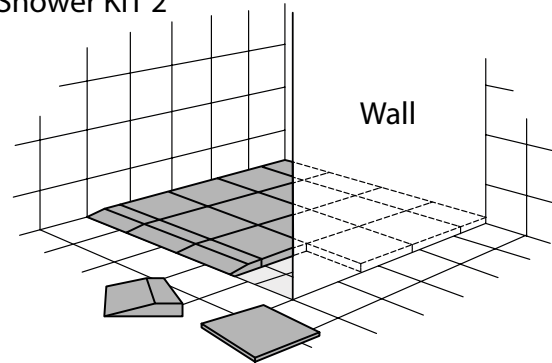

Shower KIT 3

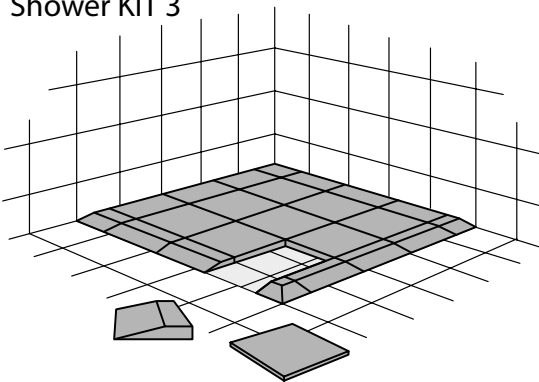

Shower KIT two layers and a KIT ramp

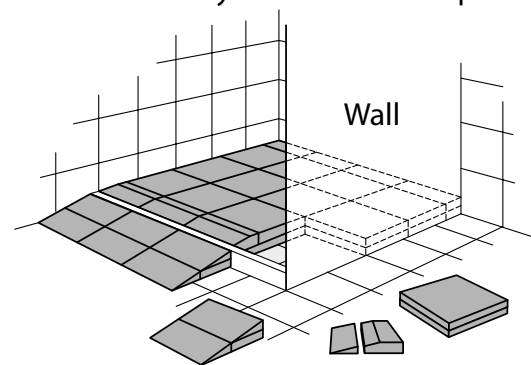

## Cleaning of Shower KIT

The surface of the tiles and ramps have no pores. And thus cannot absorb bacteria. Water and soap can easily exit, through the holes in the tiles.

We recommend cleaning the tiles every four weeks in ordinary use. The tiles tolerate all types of conventional cleaning agents. They also tolerate autoclaving (+130° C) to be sterilized.

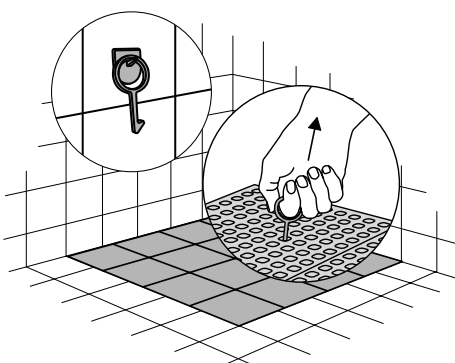
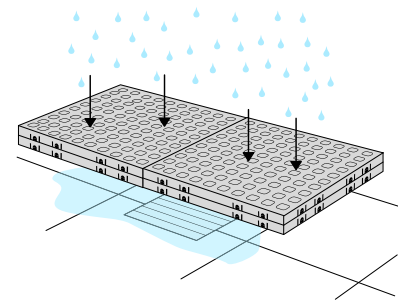

“Shower hook” makes it easy to lift the tiles in the shower.

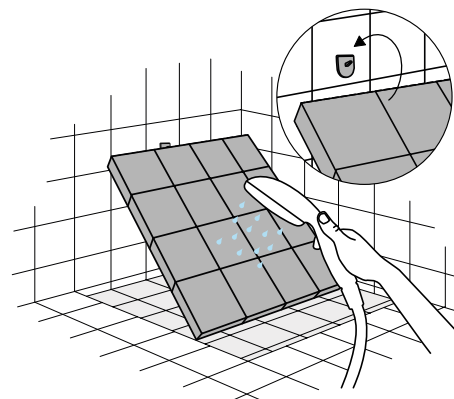

“Cleaning support” mounted on the wall, support the tiles while cleaning.

# SUSTAINABLE PRODUCTION

By reusing the PE for new products, we reduce the impact on the environment:



## Materials

All products are manufactured from the environmental friendly material PE (Polyethylene) and are:

- 100% Non-toxic
- 100% PVC-free
- 100% Reusable
- 100% Odourless

PE- Products are aciduric and non-corrosic.