

RAMP KIT 105 PLATFORM

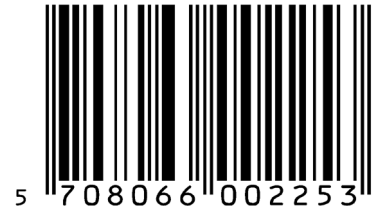

Dimensions

Depth: 75 cm

Width: 100 cm

Height:

18 cm

16,2 cm

14,4 cm

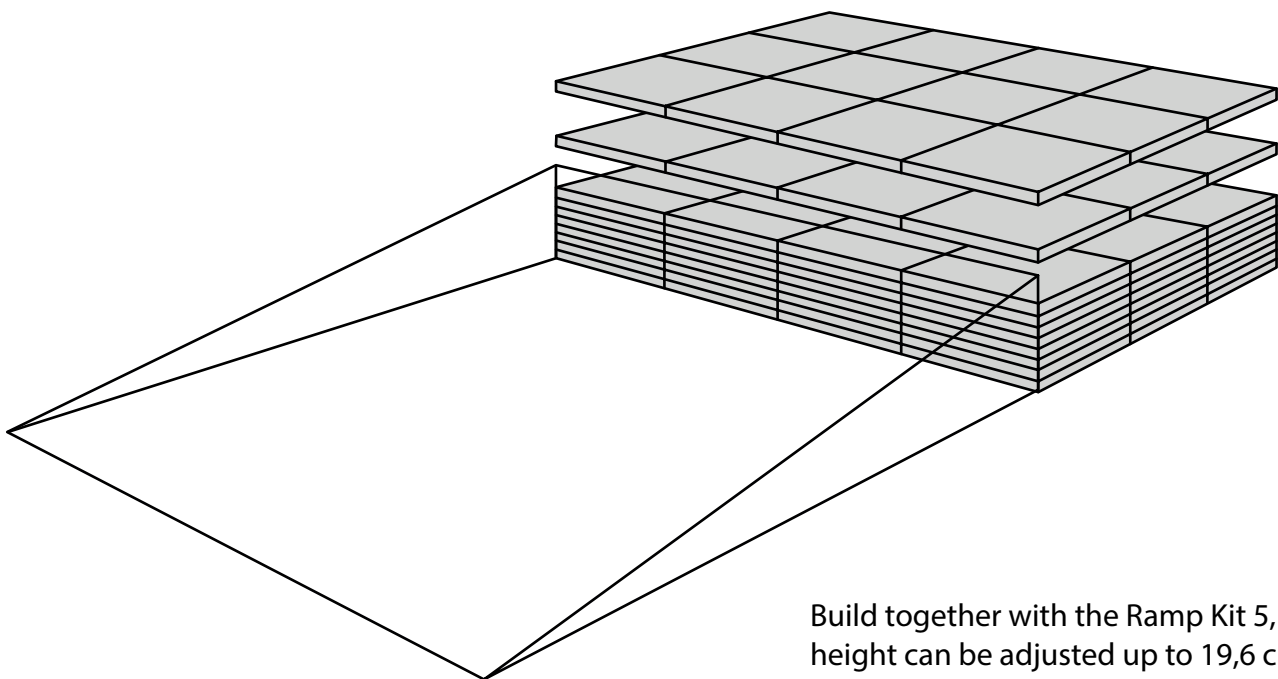

Build together with the Ramp Kit 5, the height can be adjusted up to 19,6 cm

Included

4 x

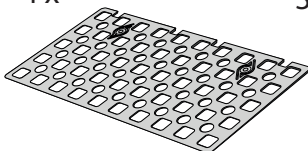

30 x

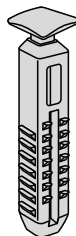

32 x

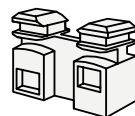

4 x

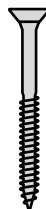

4 x



4 x

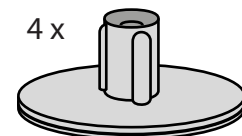

12 x



Mounted under the platform



Danish Design Pat. Pend. and produced
in Denmark by Excellent Systems A/S



HEIGHT ADJUSTMENTS

The Adjustment Key equalizes the height difference between platform and ramp.

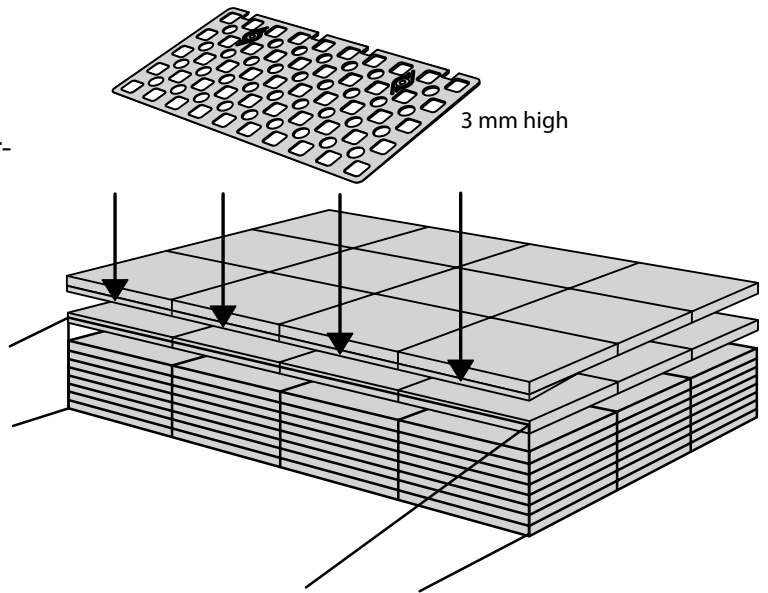
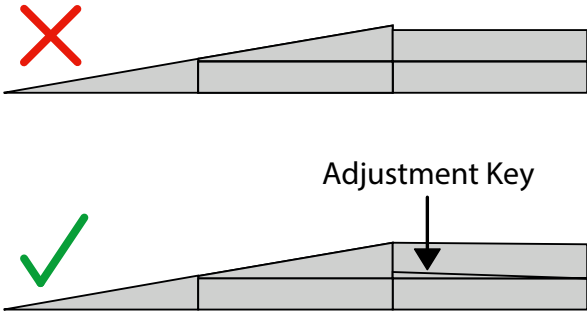

When you connect a platform and a ramp, remove the Ramp Adjuster from the ramp, and use it to adjust the platform as shown here:

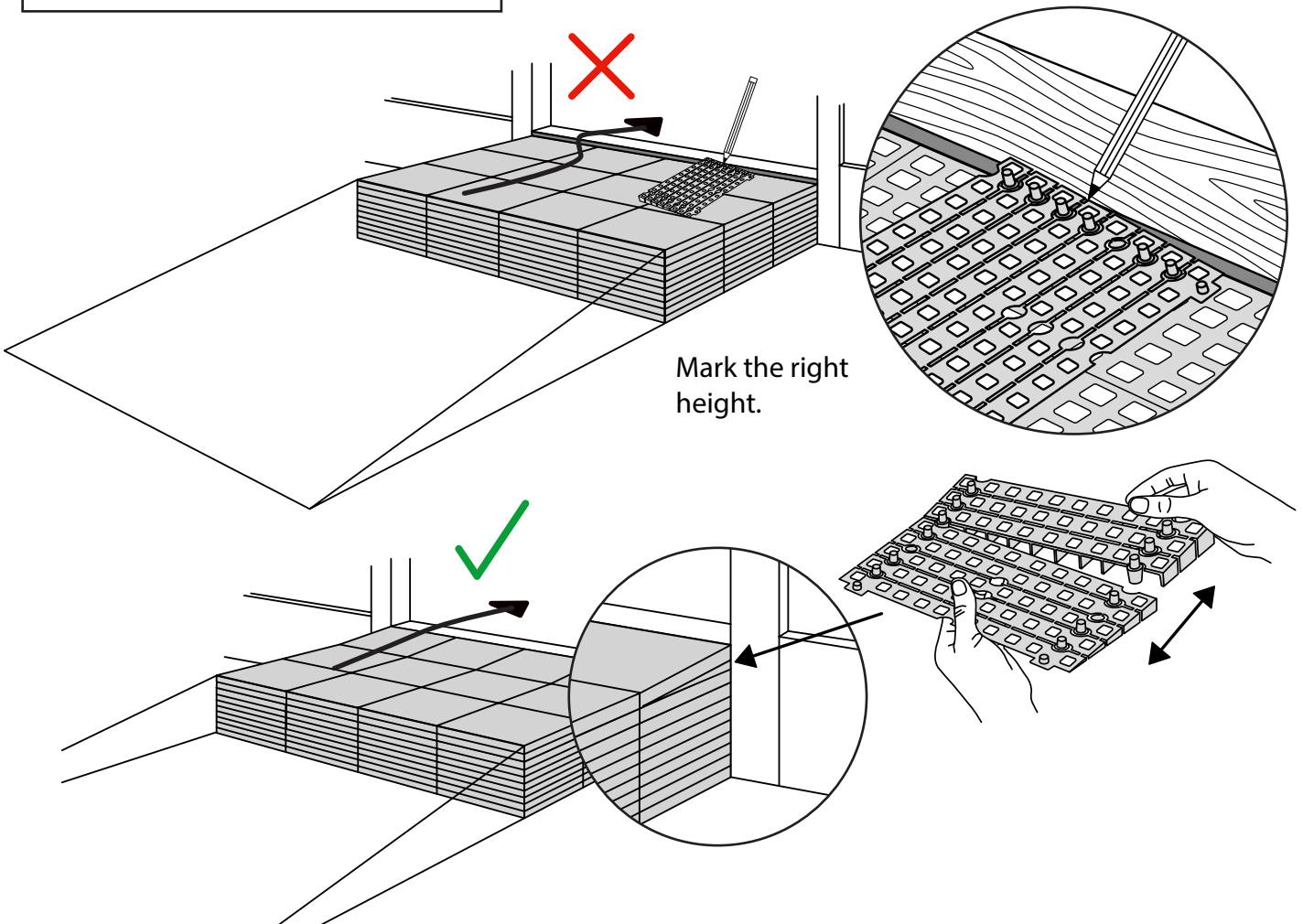
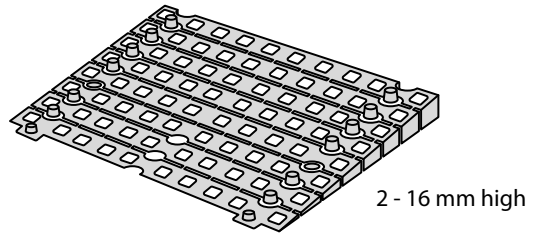
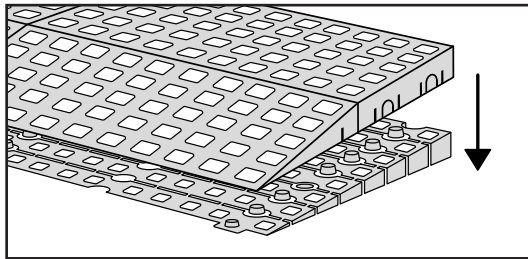

PLACEMENT OF LOCKS

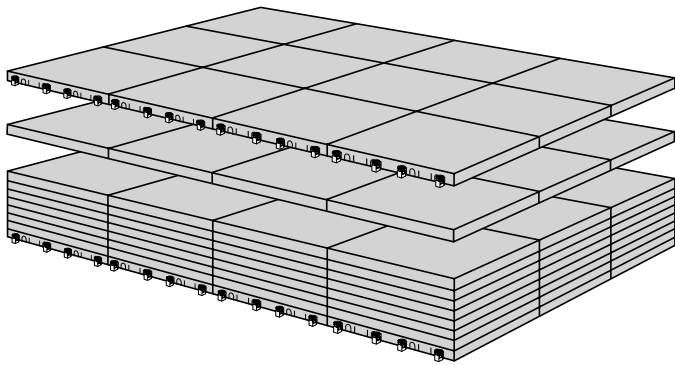

32 x

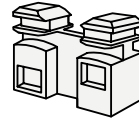

C-Lock

How to connect KIT and Platform:

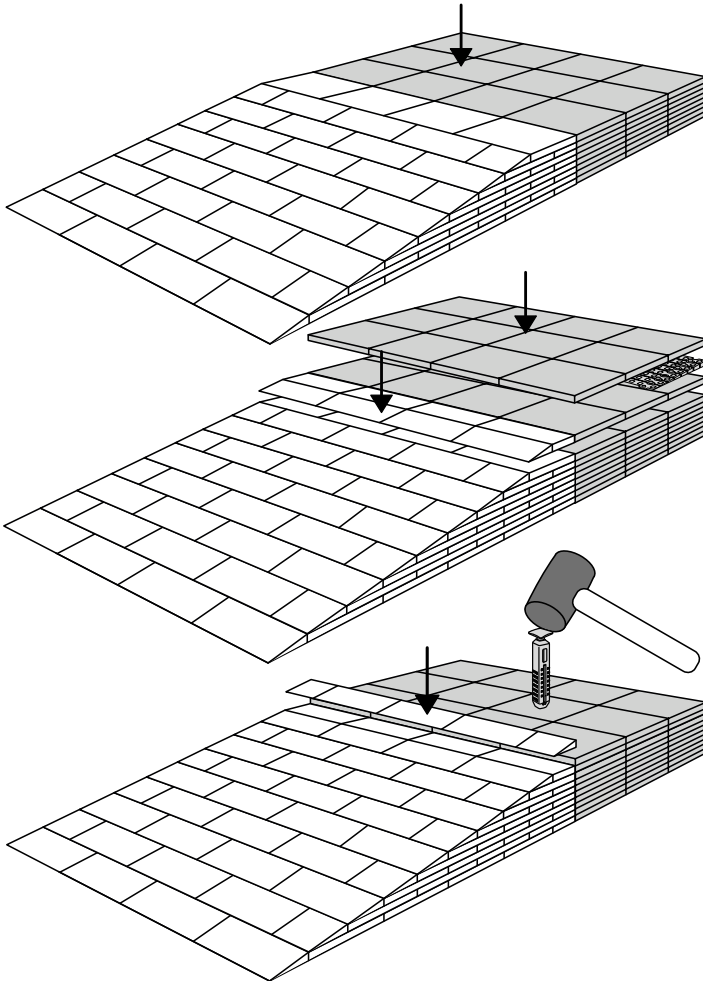

Locks in Ramp KIT:

See KIT instruction for placement of Locks in the Ramp KIT.

Locks in platform:

S-Lock is mounted on the top layer.

Use rubber hammer (Not included)

30 x

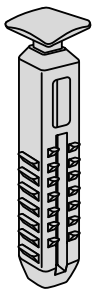

S-Lock

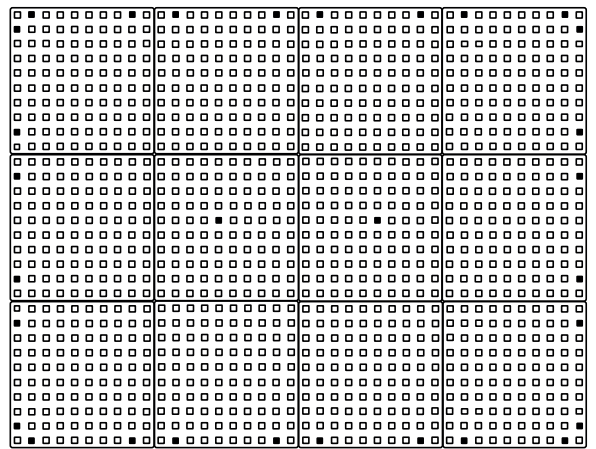

MOUNTING WITH STOPPERS

12 x

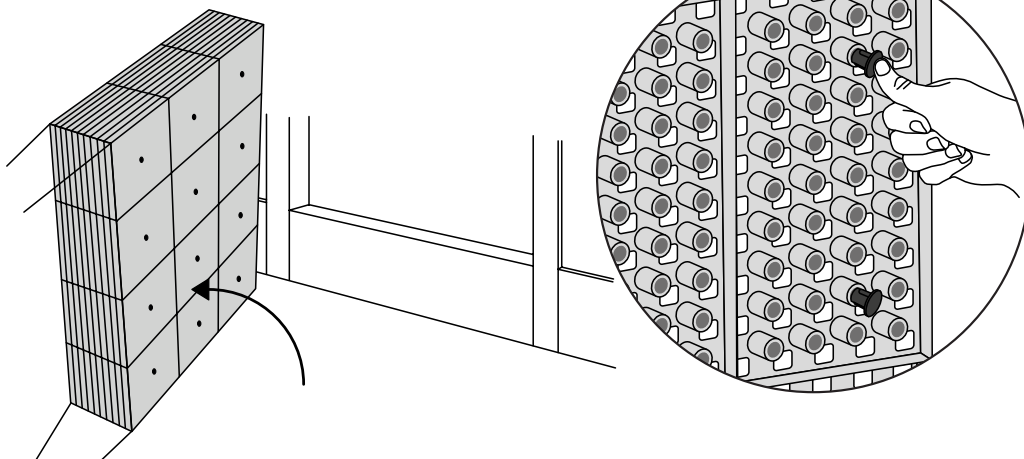

FASTENING WITH MOUNTING PADS

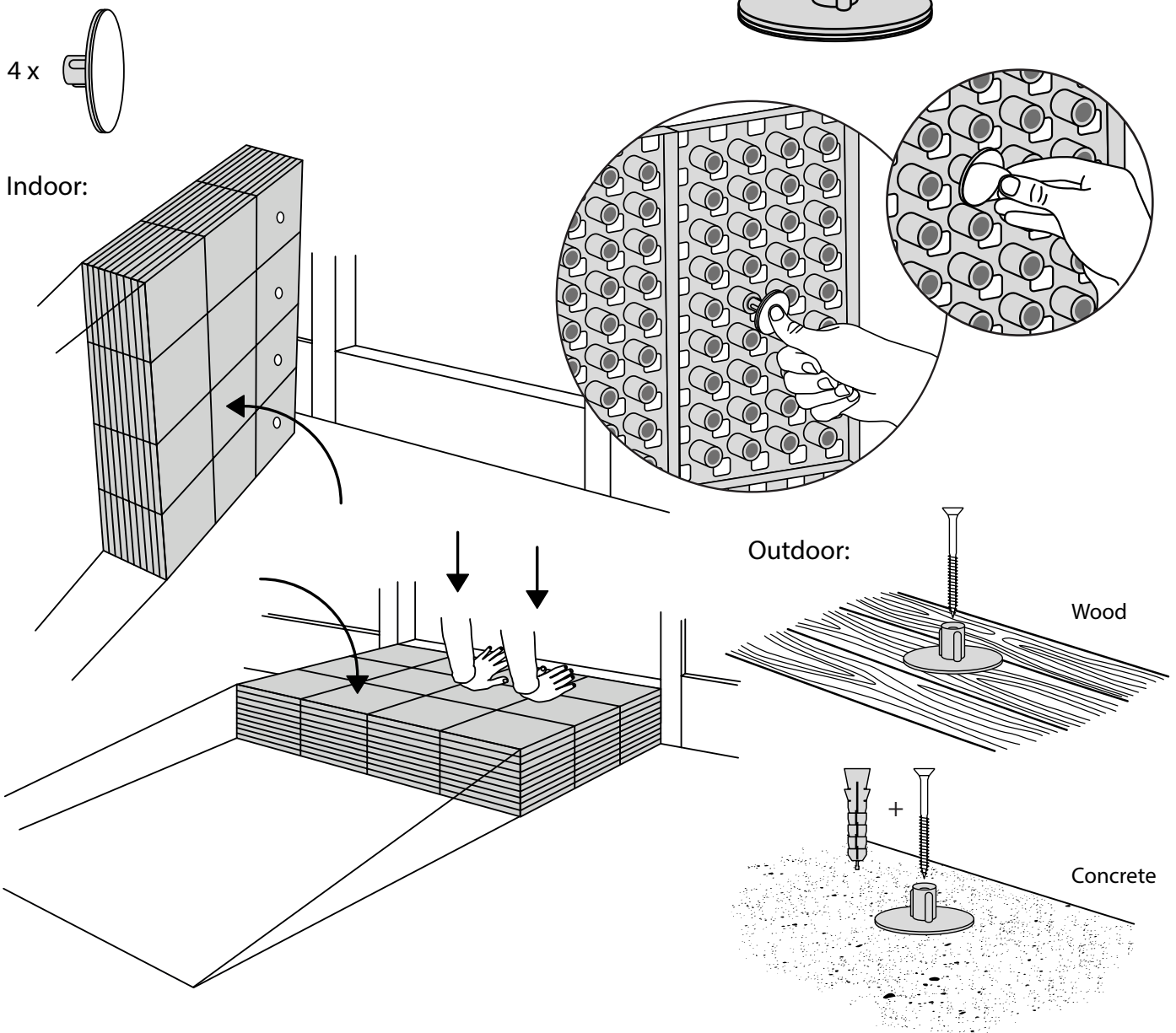

DISPOSAL



KIT and KIT parts: These products are made from PE (Polyethylen). For disposal after use we encourage you to make sure that the KIT is either returned to the point of purchase for collection and shipment back to Excellent (for regeneration), or sorted according to the recommendations in your local area.



Plastic bag: Recycled as clear LDPE plastic.



Cardboard box: Recycled as cardboard.



Brochure and instruction: Recycled as paper after end use.

