

RAMP KIT 5 PLATFORM



Dimensions

Depth: 75 cm

Width: 75 cm

Height:

18 cm

16,2 cm

14,4 cm

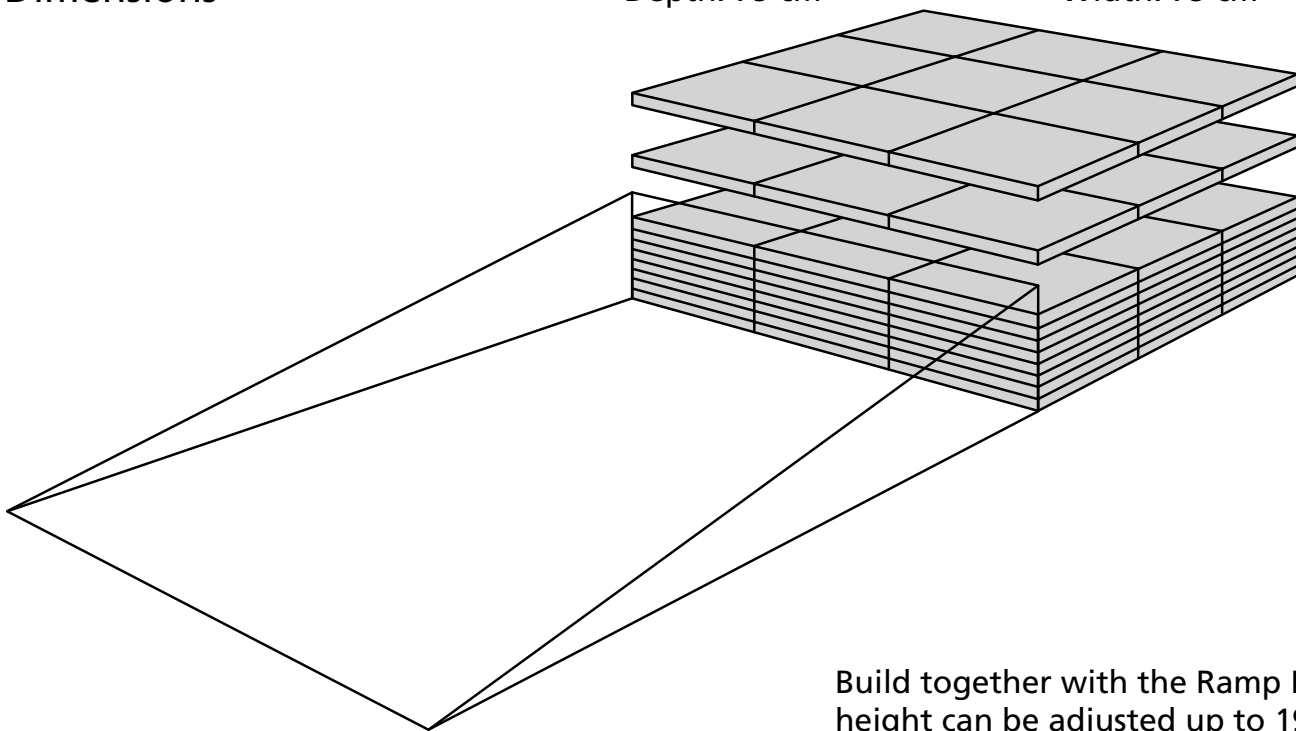

Build together with the Ramp Kit 5, the height can be adjusted up to 19,6 cm

Included

3 x

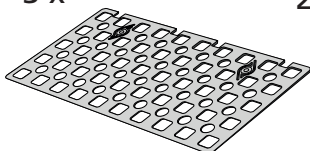

25 x

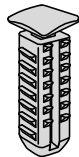

24 x

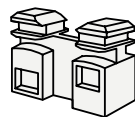

3 x

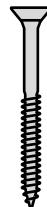

3 x



3 x

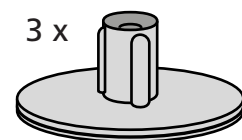

9 x

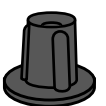

Mounted under the platform



Danish Design Pat. Pend. and produced
in Denmark by Excellent Systems A/S



HEIGHT ADJUSTMENTS

The Adjustment Key equalizes the height difference between platform and ramp.

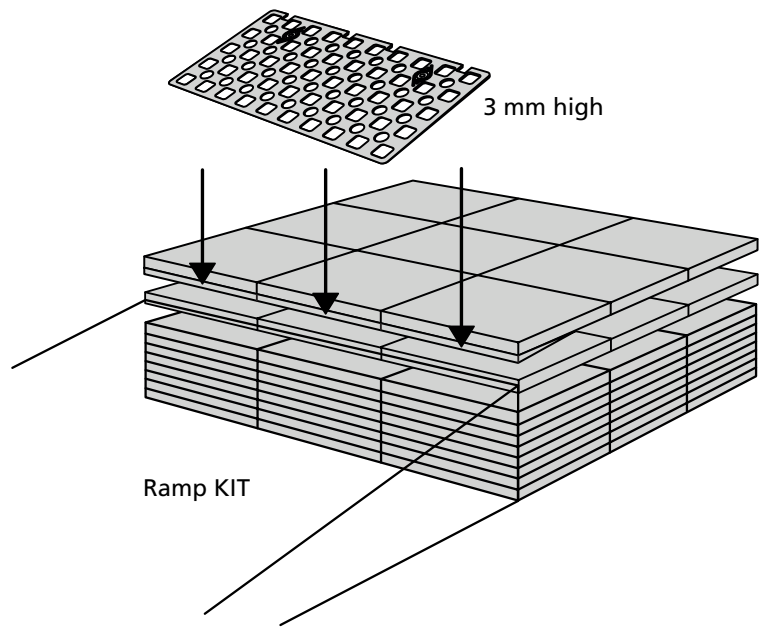
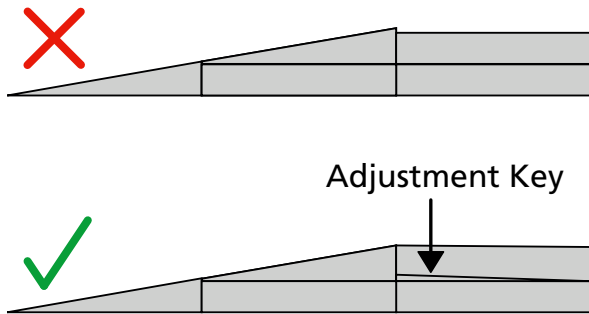

When you connect a **platform** and a **ramp**, remove the **Ramp Adjuster** from the ramp, and use it to adjust the platform as shown here:

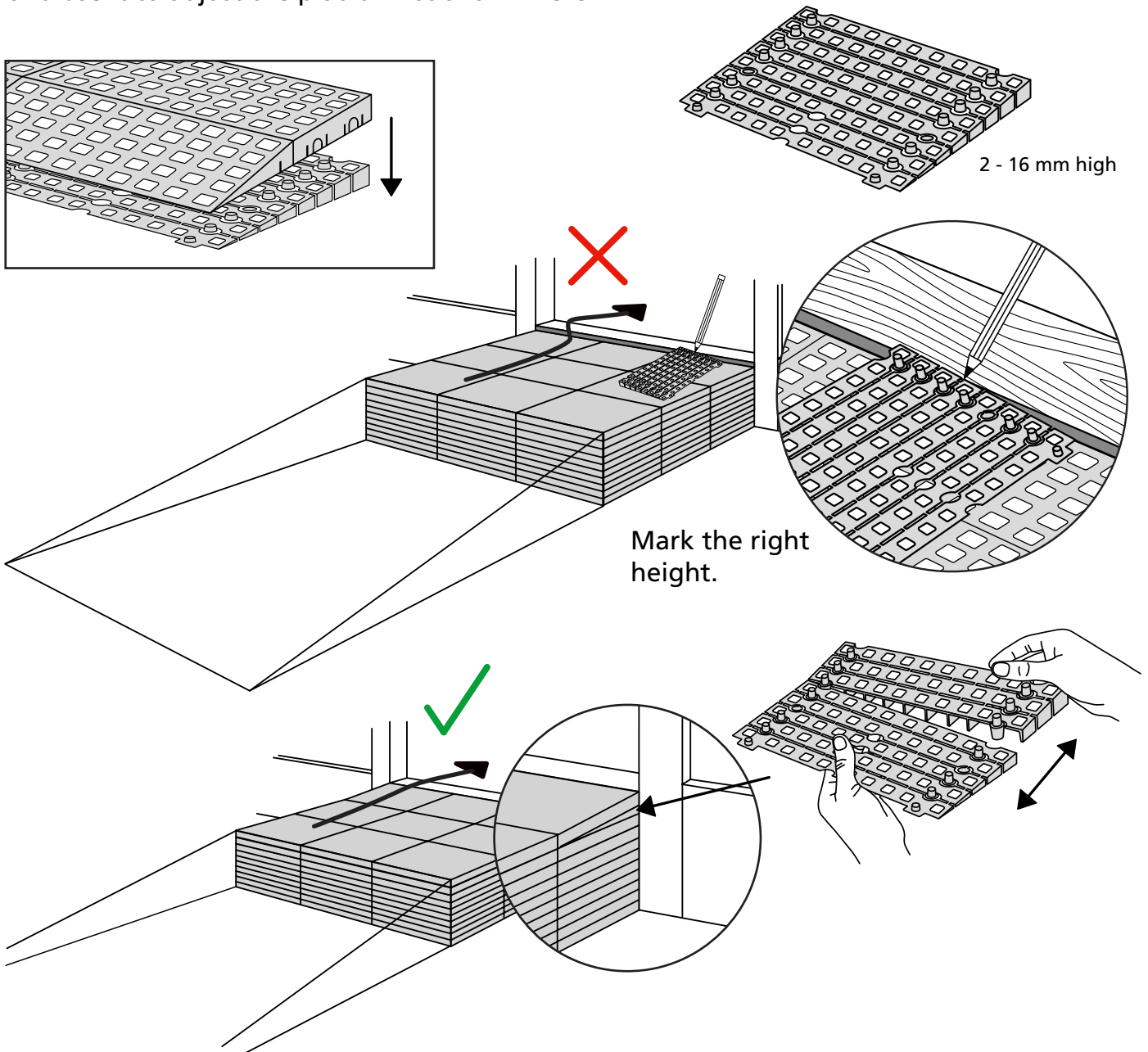

MOUNTING WITH LOCKS

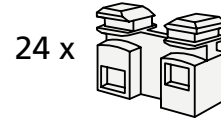
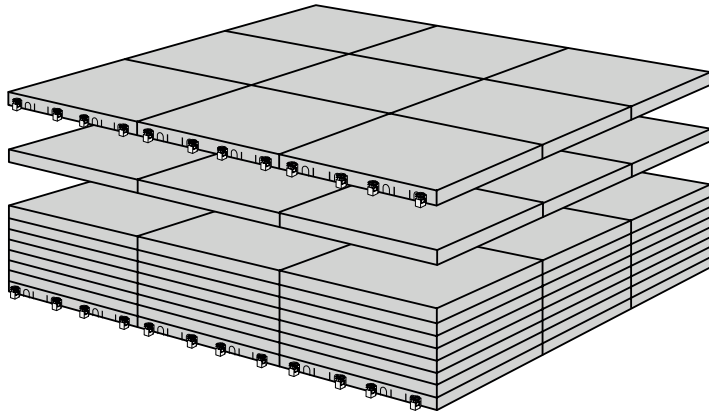

C-Lock

How to connect KIT and Platform:

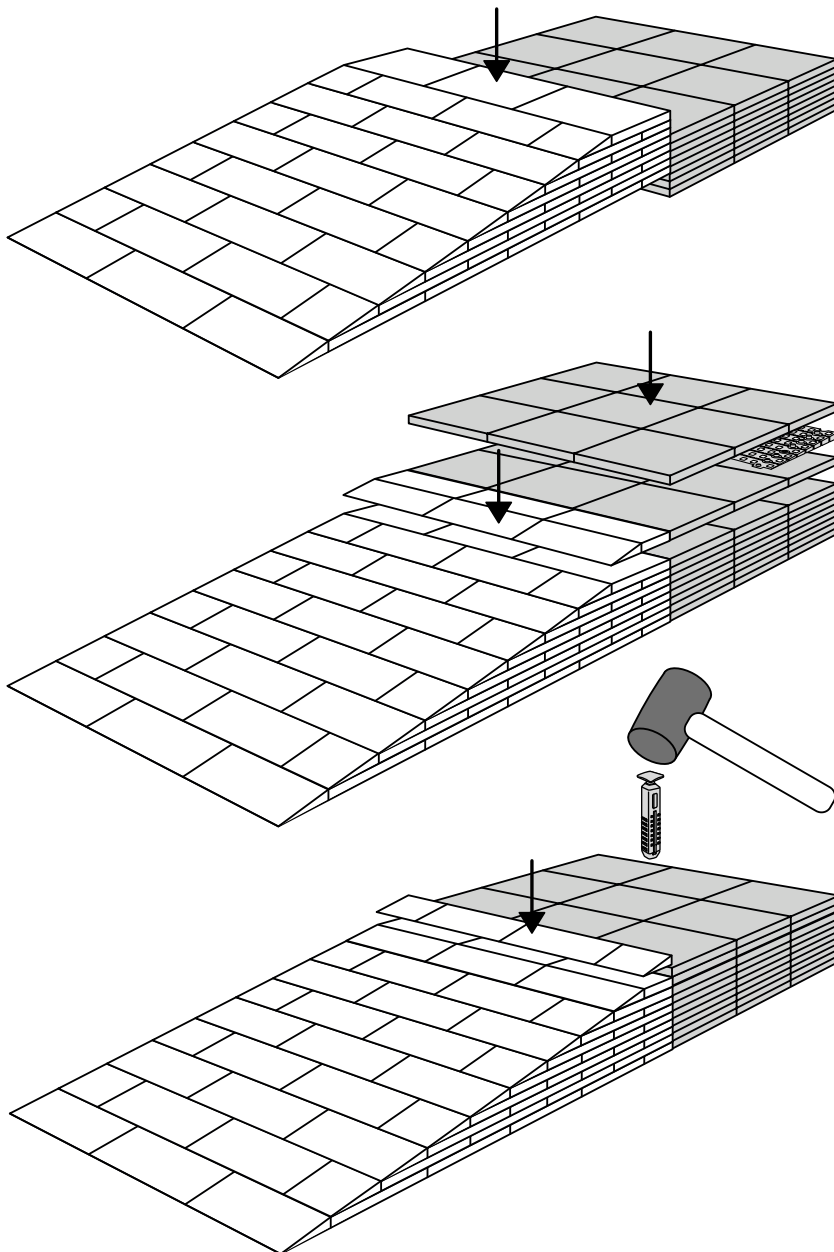

Locks in Ramp KIT:
See KIT instruction for placement
of Locks in the Ramp KIT.

Locks in platform:
S-Lock is mounted
on the top layer.

Use rubber hammer
(Not included)

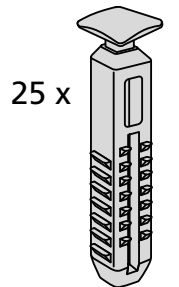

S-Lock

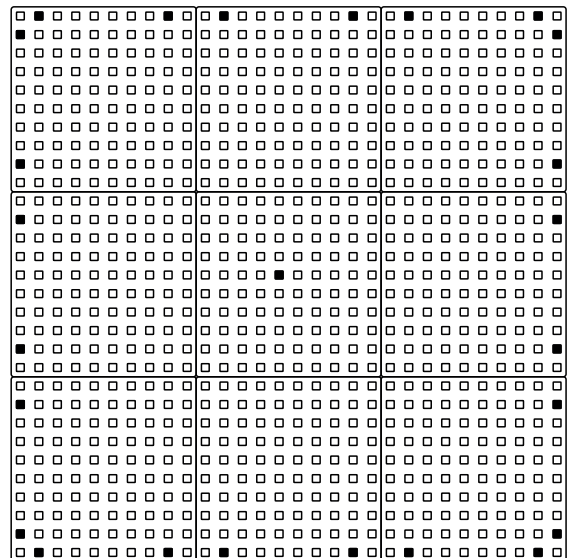

FASTENING WITH MOUNTING PADS

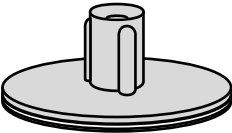

Indoor:

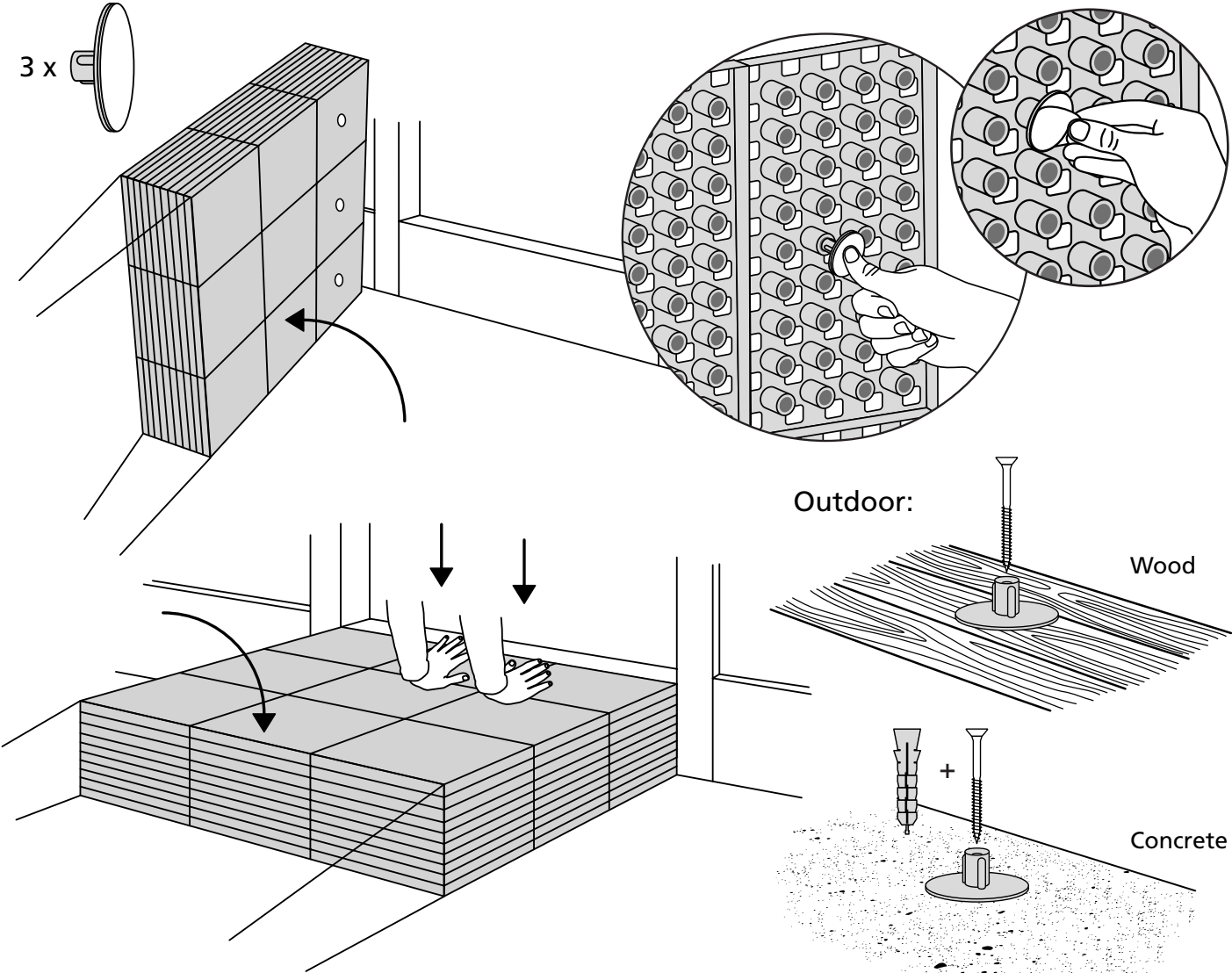

MOUNTING WITH STOPPERS

