

# SHOWER SOLUTIONS

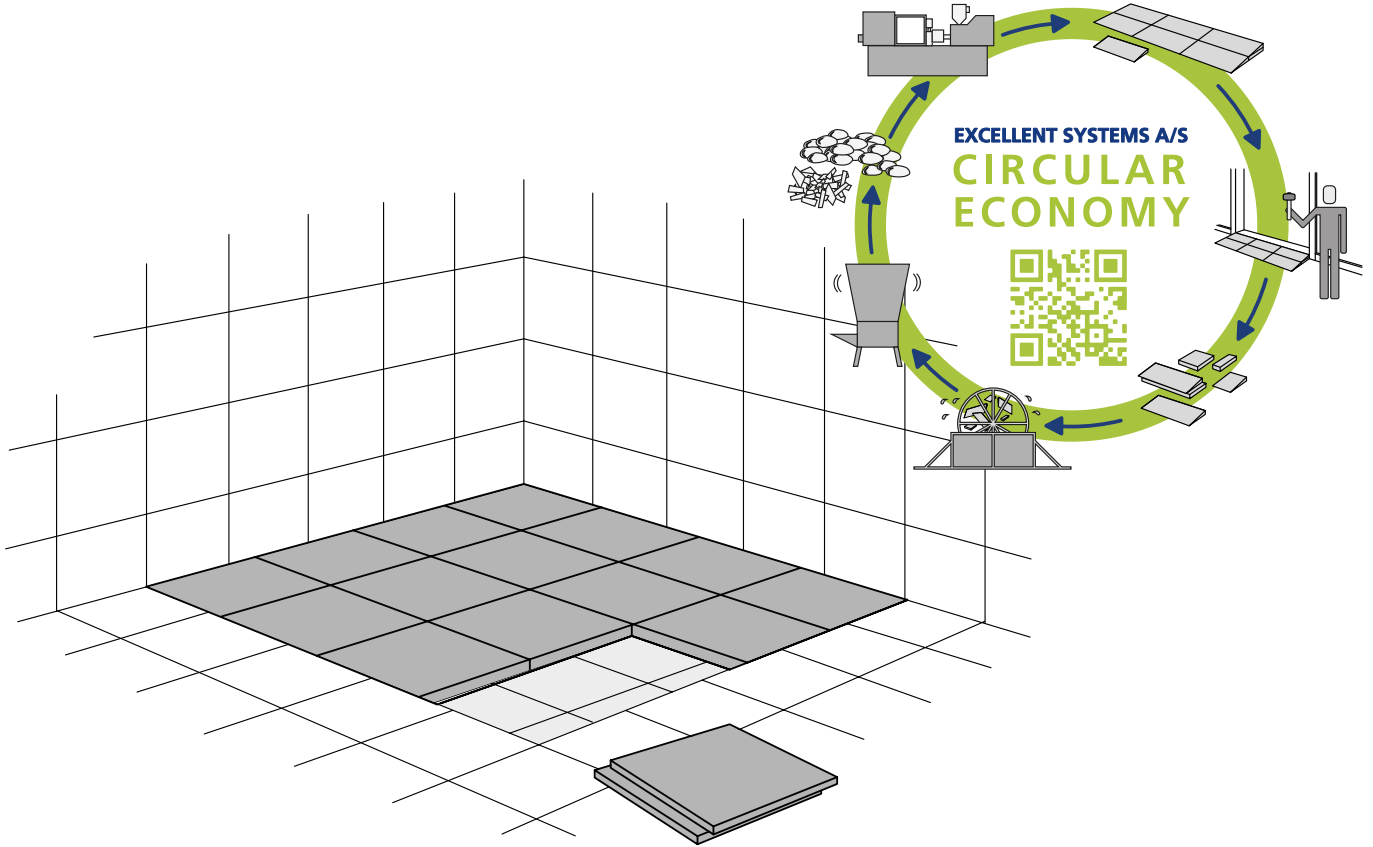

Shower KIT 1

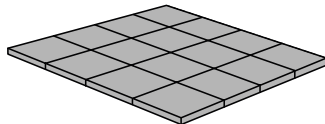

Shower KIT 2

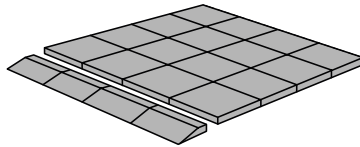

Shower KIT 3

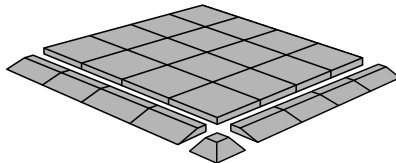

**excellent** systems as

[excellent-kit.com](http://excellent-kit.com)

# ABOUT SHOWER KITS

---

The shower can be a dangerous place, due to water or soap on the surface you walk on, or stumbling over the raised edge of a shower tray or recessed shower area.

Excellent Systems A/S have developed a solution using slip resistant self draining tiles which are placed within the shower area, so the floor becomes less slippery, and can be leveled to the required height, eliminating any stumbling or trip hazard.

The tiles and ramps are made of PELD which is approved for foodstuff. This material is highly suited for showers, because the surface is non-porous so no bacteria can enter the material, leaving the surface is very easy to disinfect.

As our flooring system can easily take the weight of a car, it is safe to use with heavy wheelchairs and shower commodes. You might also need our Ramp Kit to assist with the entrance in to a shower area.

Our company has made flooring in showers, access for wheelchairs and shower commodes for more than 20 years. Our installation experience has enabled us to make a series of 3 Shower KITS, which alone or in combination, make it possible to cover your shower area, no matter if you need 1, 2 or 4 layers to reach the top of the tray. Always be sure when placing the flooring, that it fits closely to all sides, to avoid the tiles to moving.

Within each package there is an installation guide.

Visit [www.excellent-kit.com](http://www.excellent-kit.com) for installation videos and guidance.

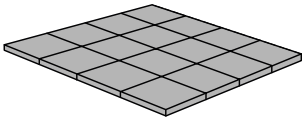
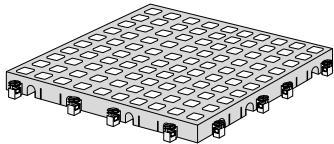
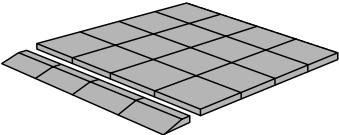
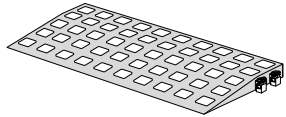
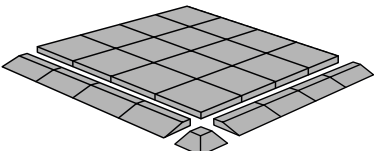
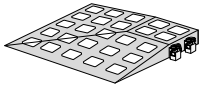
|  | Content                                      | Dimensions  |
|--|--|---|
| <b>Shower KIT 1</b><br> | 16 tiles = 1 sqm                             | Tile<br>W: 25x25 cm<br>H: 18 mm<br>            |
| <b>Shower KIT 2</b><br> | 16 tiles = 1 sqm<br>4 ramps                  | Ramp<br>W: 13,7x25 cm<br>H: 18 mm<br>          |
| <b>Shower KIT 3</b><br> | 16 tiles = 1 sqm<br>8 ramps<br>1 corner ramp | Corner ramp<br>W: 13,7x13,7 cm<br>H: 18 mm<br> |

# IMPORTANT GUIDELINES

Maximum height difference from tray edge or tiles to shower area: 2 mm

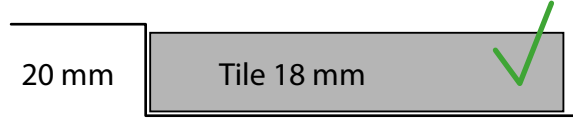
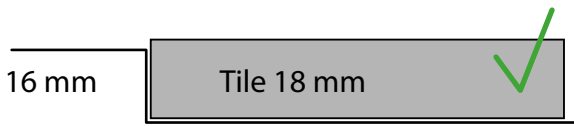

Always fit the tiles close to the edge to avoid undue movement:



Always fill up the whole shower area to avoid accidents:

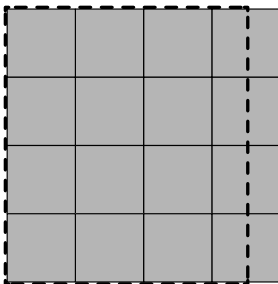

Shower area: 75 x 100 cm  
Use one KIT 1

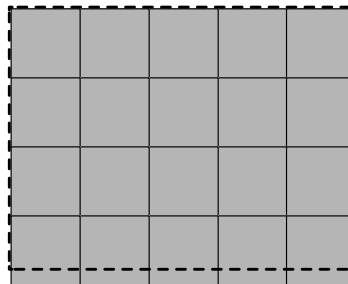

Shower area: 125 x 95 cm  
Use two KIT 1

To avoid accidents, we kindly recommend you do not use a Shower KIT, if the edges of the tray are rounded excessively as illustrated:

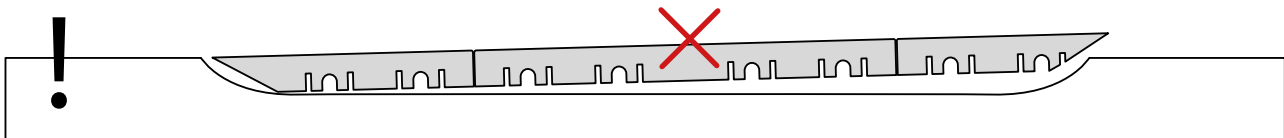

# SHOWER KIT 1

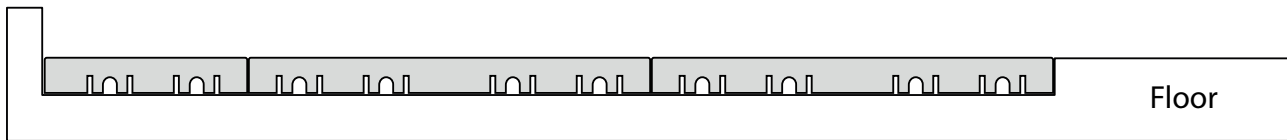

Use Shower KIT 1 if the recess area fits the height of one tile.  
You will find information about solutions with multiple layers on page 7.



▶ Shower KIT 1

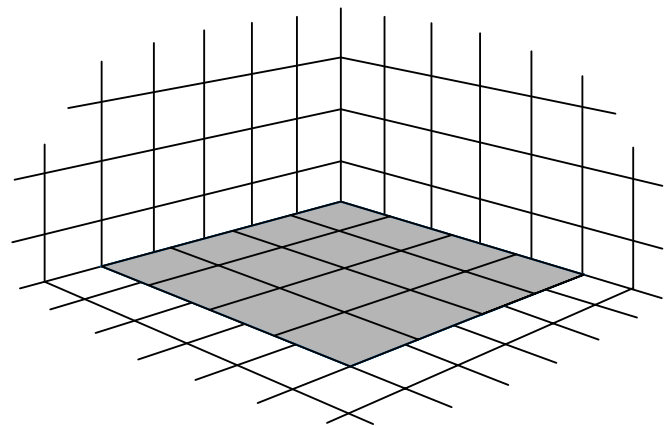
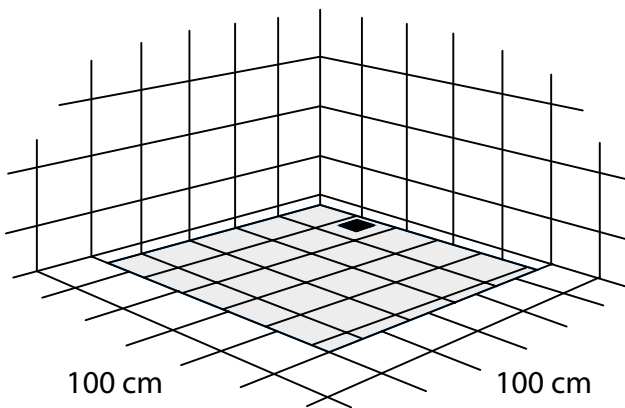
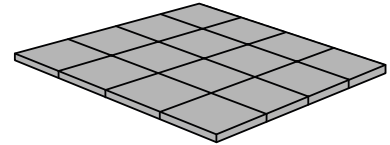

Other solutions:

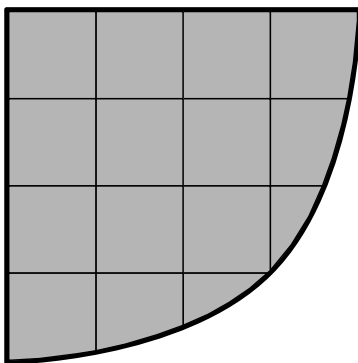

Rounded shower.

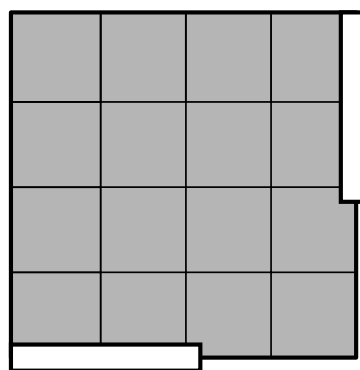

Shower with walls and a sloping edge.

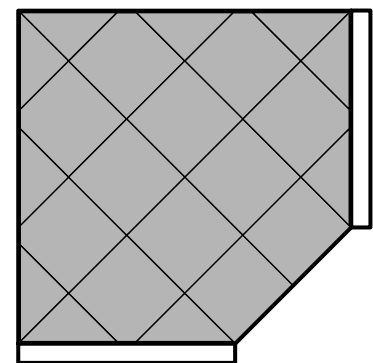

Shower area with walls and a sloping edge.

# SHOWER KIT 2

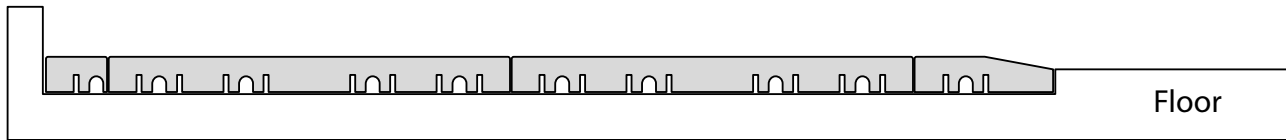

Use Shower KIT 2, if the shower recess area is more than 2 mm lower than the tiles or tray edge.



Shower KIT 2

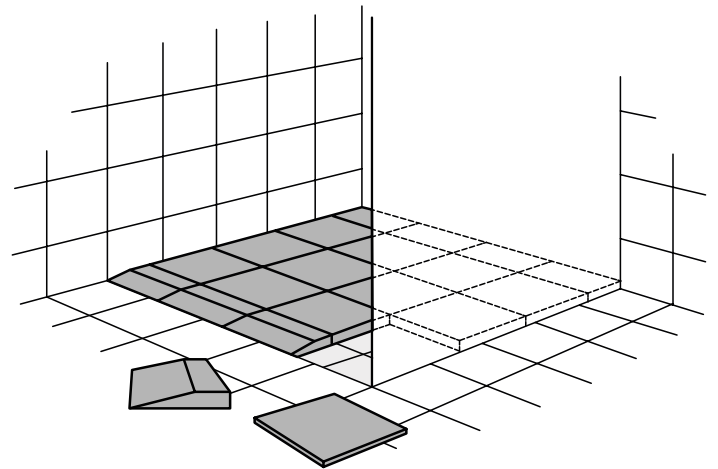
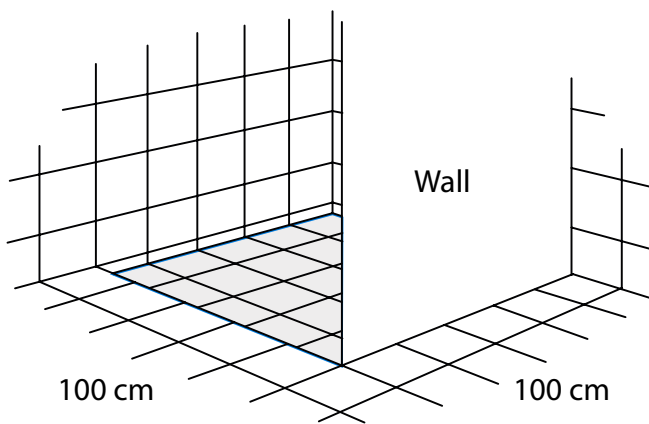
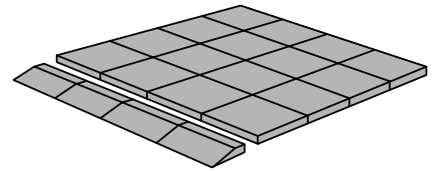

Other solutions:

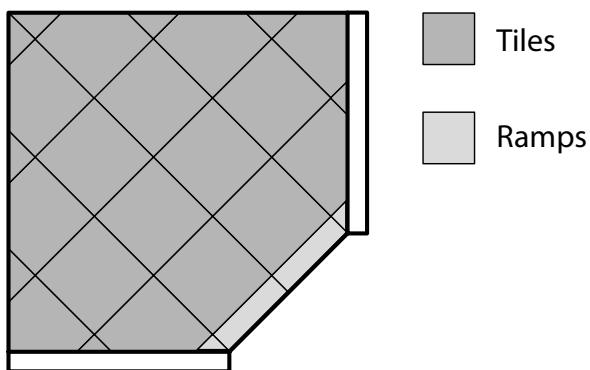

Shower area with walls and a sloping edge.

# SHOWER KIT 3

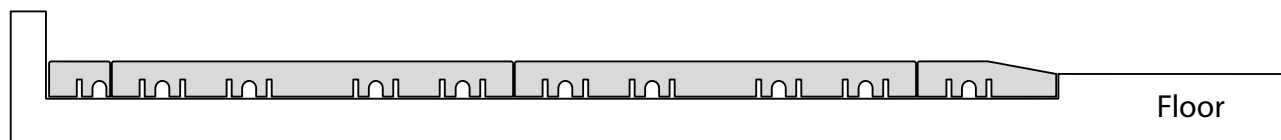

Use Shower KIT 3, if the shower recess area is more than 2 mm lower than the tiles, and has an open corner.



Shower KIT 3

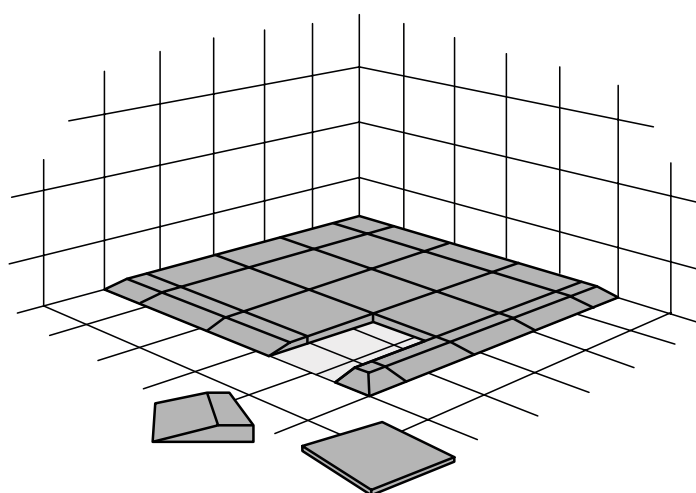
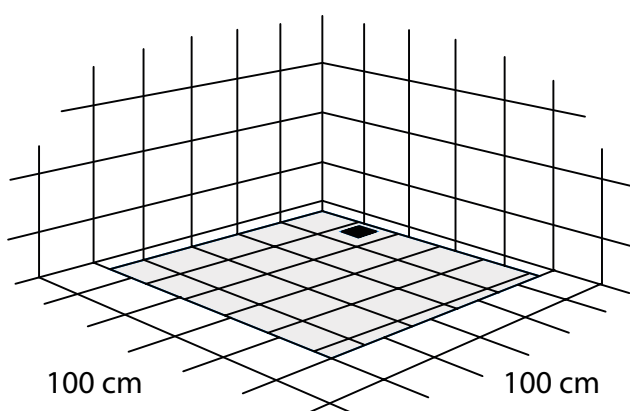
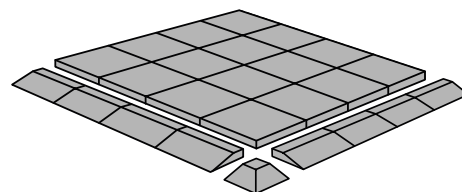

Other solutions:

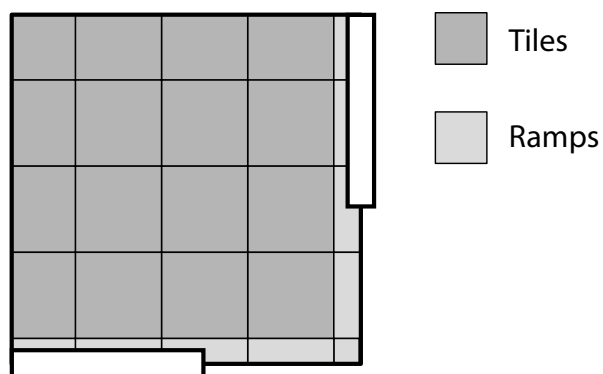

Shower area with walls and a corner entry.

# MULTIPLE LAYERS

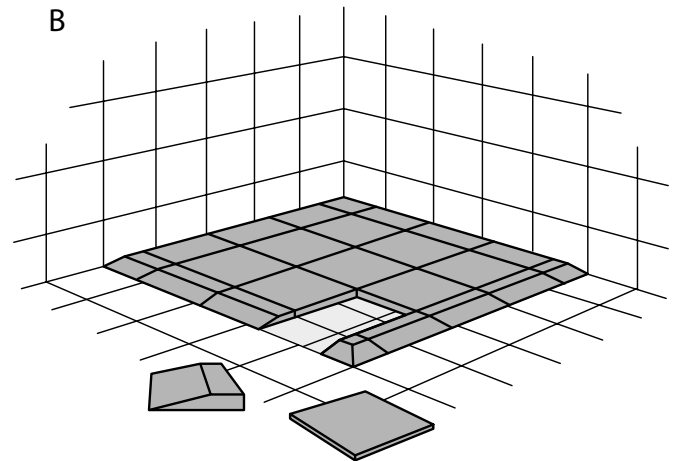
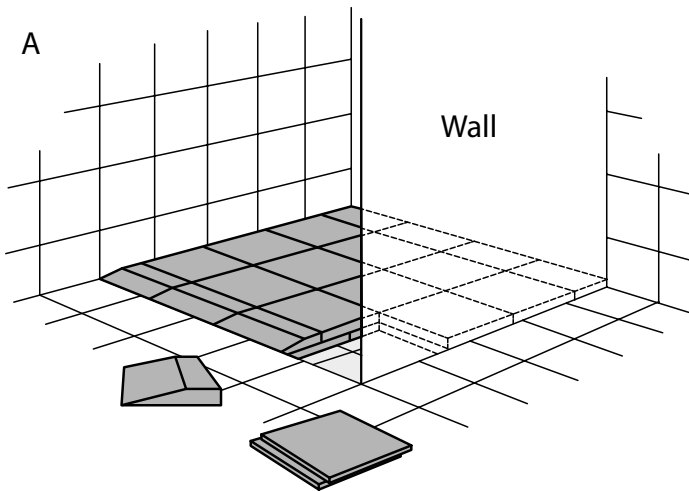
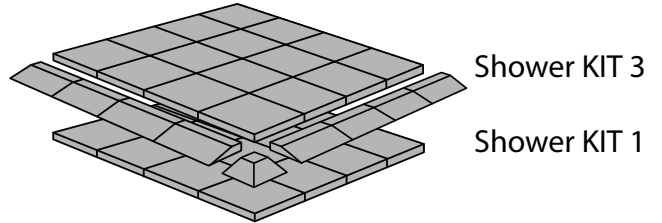
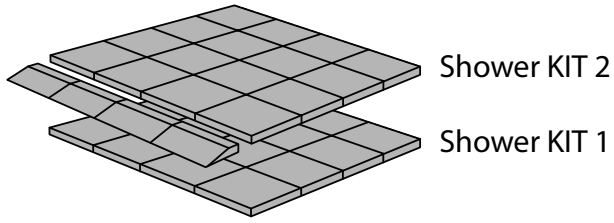
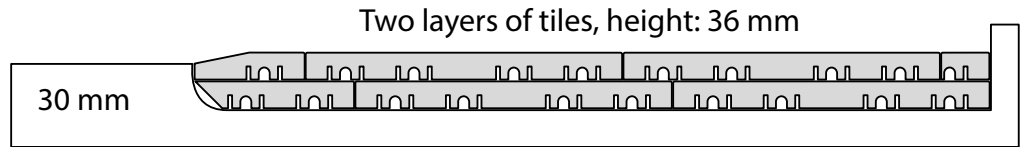

# RAMP KIT ON THE OUTSIDE OF A SHOWER TRAY

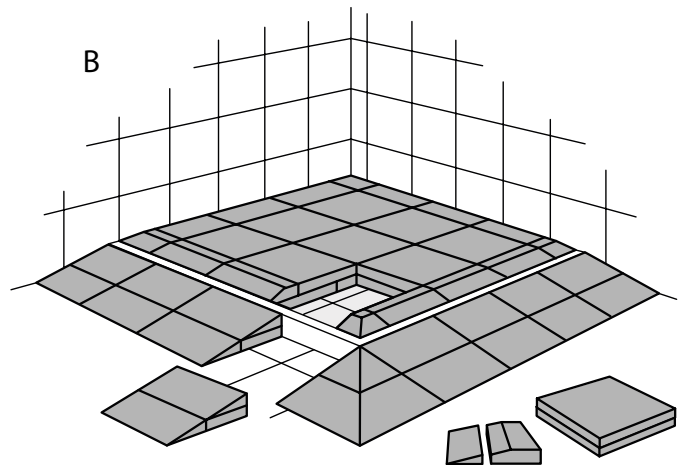
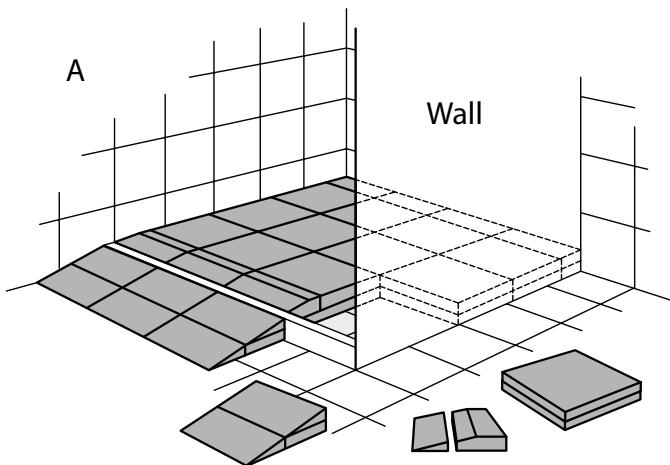
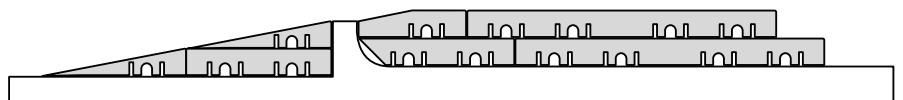

Use one Ramp KIT 1 on the outside of the shower tray.  
See Ramp KIT 1 instruction.

Use two Ramp KIT 1 + one corner on the outside of the shower tray.  
See Ramp KIT 1 + corner instruction.



## Cleaning of Shower KIT

The surface of the tiles and ramps have no pores. And thus cannot absorb bacteria. Water and soap can easily exit, through the holes in the tiles.

We recommend cleaning the tiles every four weeks in ordinary use. The tiles tolerate all types of conventional cleaning agents. They also tolerate autoclaving (+130° C) to be sterilized.

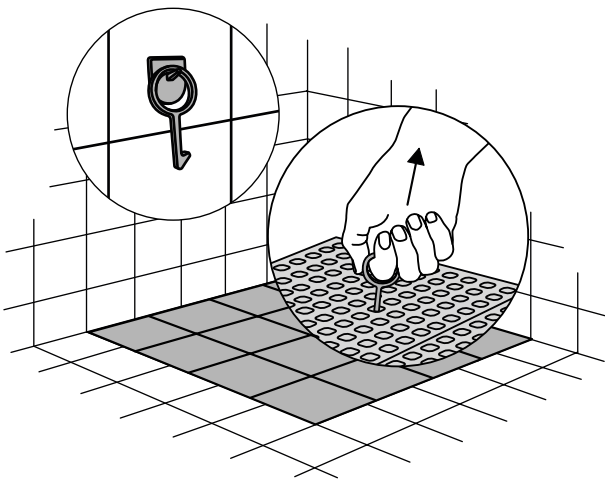
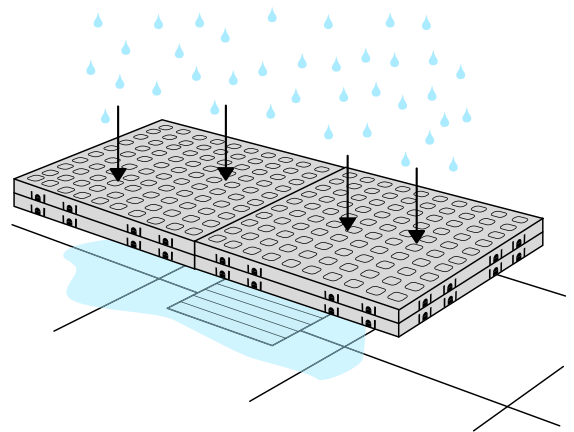

“Shower hook” makes it easy to lift the tiles in the shower.

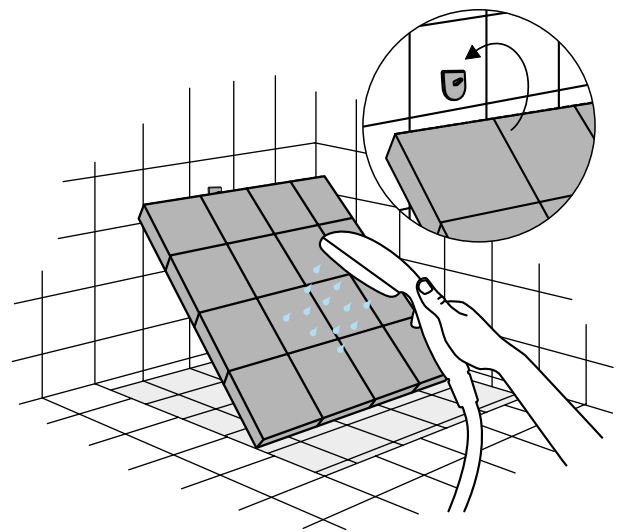

“Cleaning support” mounted on the wall, support the tiles while cleaning.