

# SHOWER KIT 2

Tile: 16 pcs.  
Width: 25 x 25 cm  
Height: 18 mm

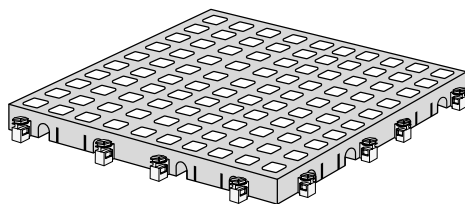

Ramps: 4 pcs.  
Width: 13,7 x 25 cm  
Height: 18 mm

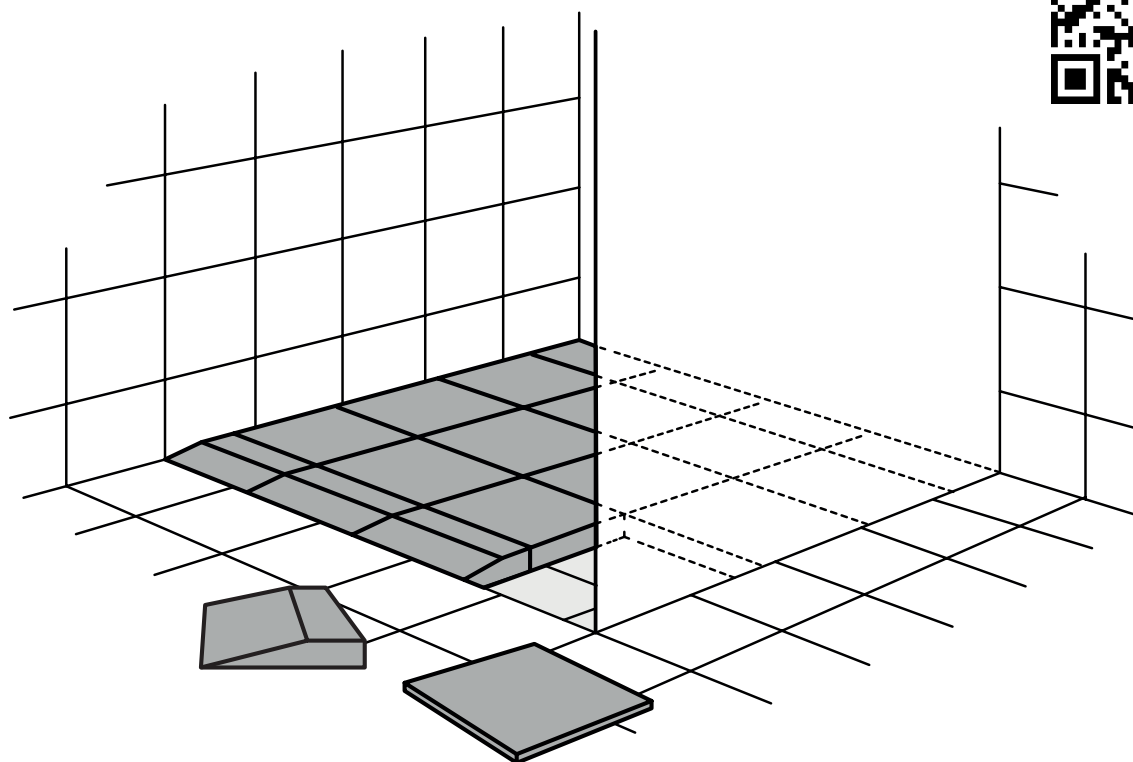
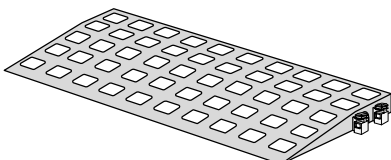

USE ONLY FOR SHOWERS UP TO 100X100 CM.  
FOR BIGGER SHOWERS, USE TWO KIT 1'S.

ALWAYS FILL UP THE WHOLE SHOWER AREA TO AVOID ACCIDENTS.



Danish Design Pat. Pend. and produced  
in Denmark by Excellent Systems A/S



# IMPORTANT GUIDELINES

Maximum height difference from tray edge or tiles to shower area: 2 mm

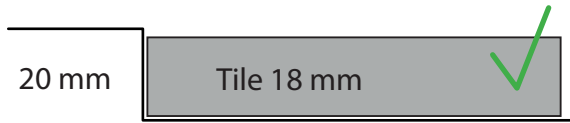
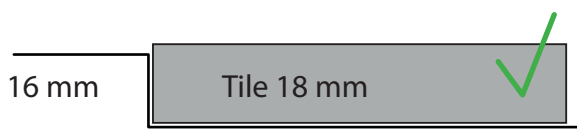

Always fit the tiles close to the edge to avoid undue movement:



To avoid accidents, we kindly recommend you do not use a Shower KIT, if the edges of the tray are rounded excessively as illustrated:

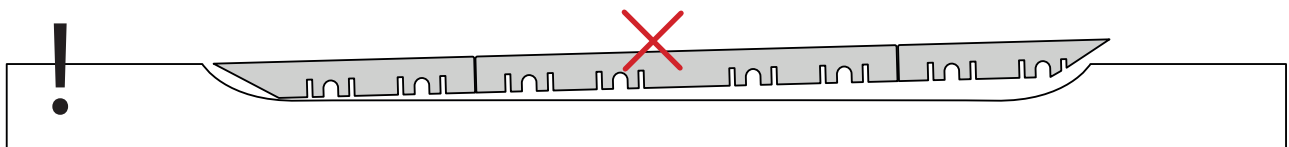

## SHOWER KIT 2 CONTENT

Tiles: 16 pcs.  
Width: 25 x 25 cm  
Height: 18 mm

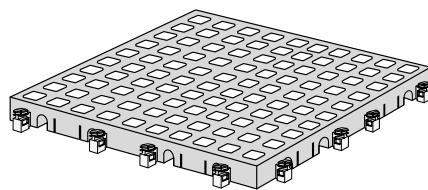

Shower hook  
+ shower support



Ramps: 4 pcs.  
Width: 13,7 x 25 cm  
Height: 18 mm

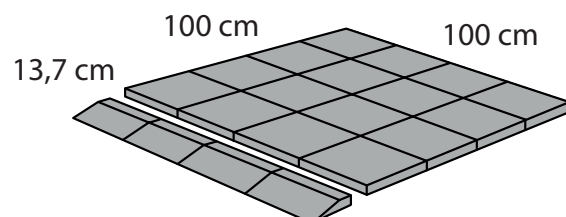
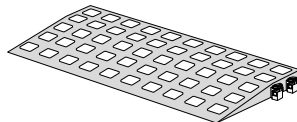

# SHOWER KIT 2 INSTALLATION

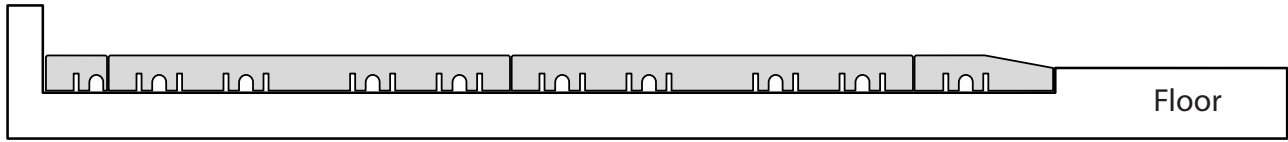

Use Shower KIT 2, if the shower recess area is more than 2 mm lower than the tiles or tray edge.

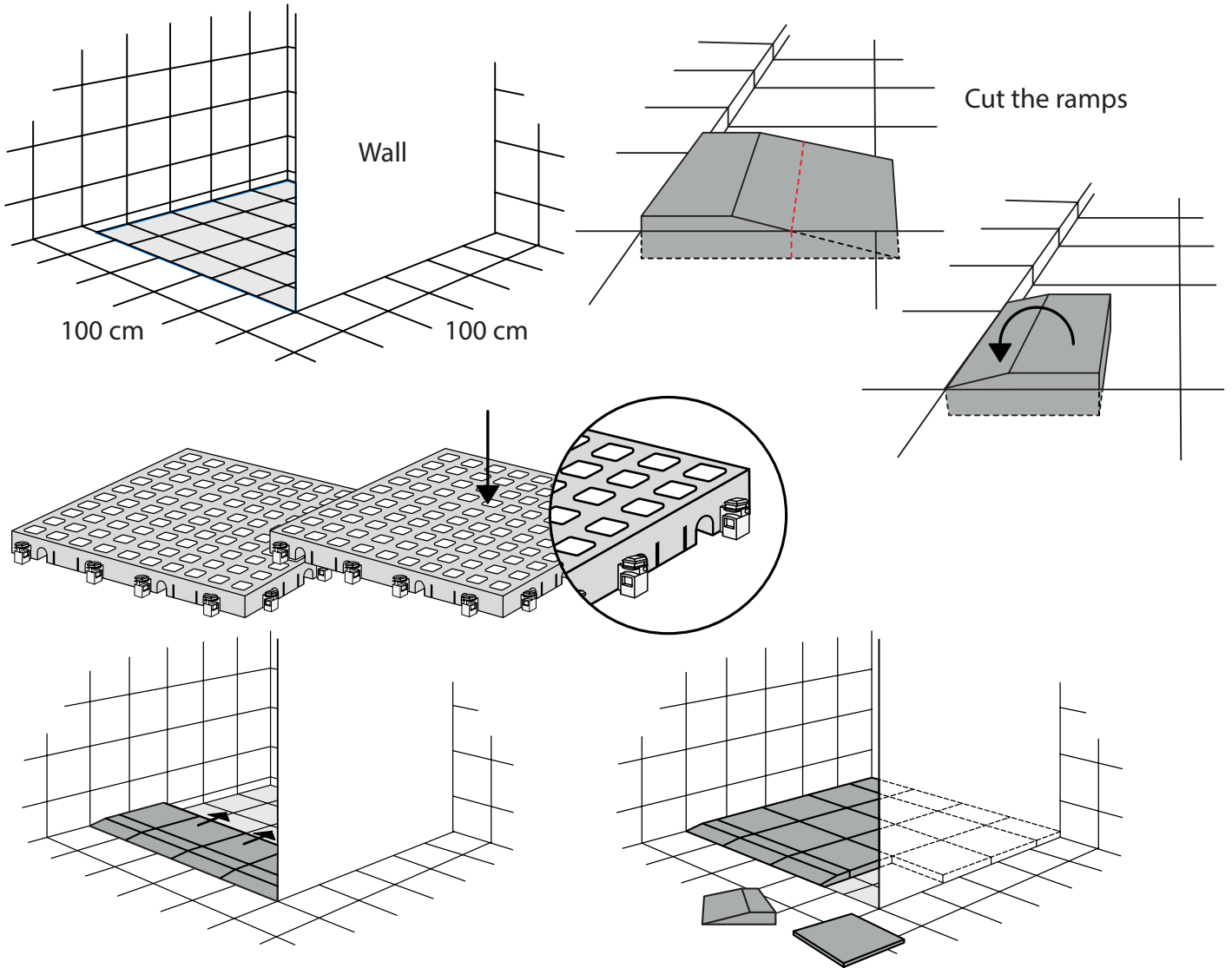

Should fitting become necessary, it can be done with an ordinary jigsaw.

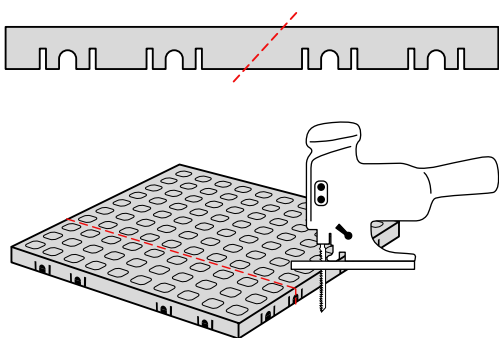

## Other solutions

Shower area with walls and a sloping edge.

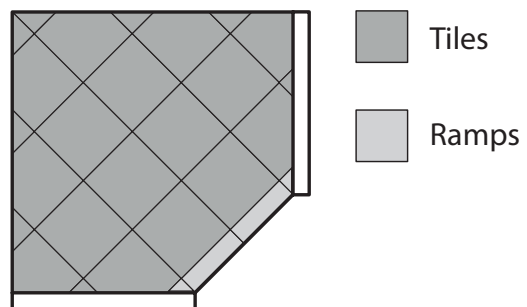

# CLEANING OF SHOWER KIT

The surface of the tiles and ramps have no pores. And thus cannot absorb bacteria. Water and soap can easily exit, through the holes in the tiles.

We recommend cleaning the tiles every four weeks in ordinary use. The tiles tolerate all types of conventional cleaning agents. They also tolerate autoclaving (+130° C) to be sterilized.

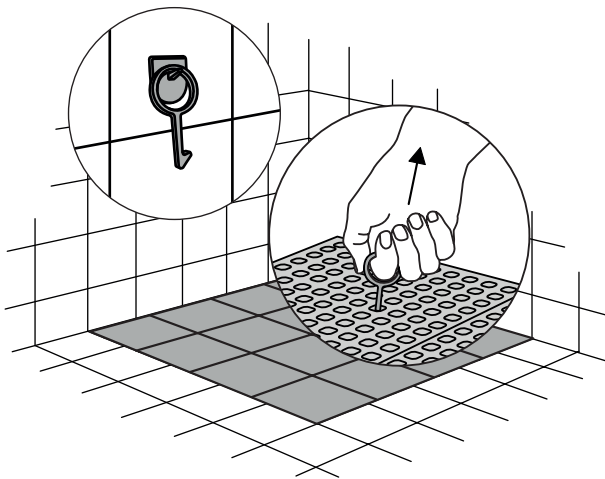
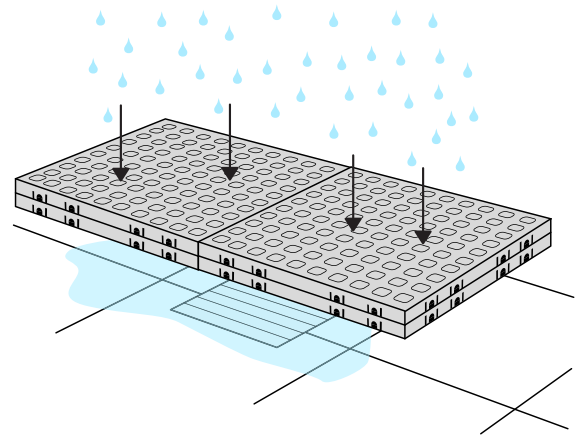

“Shower hook” makes it easy to lift the tiles in the shower.

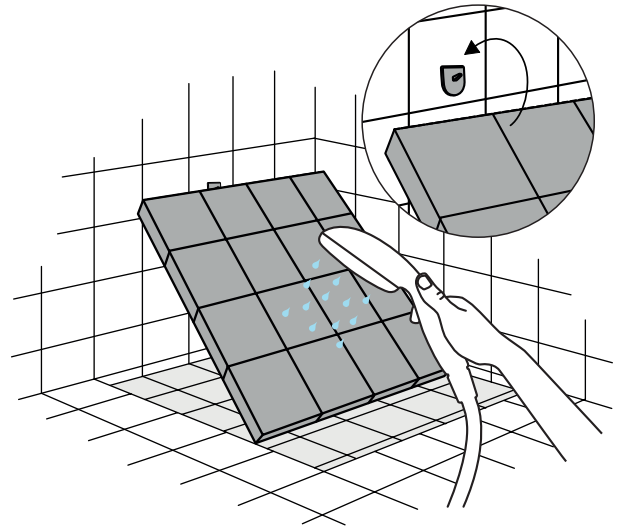

“Cleaning support” mounted on the wall, support the tiles while cleaning.

## DISPOSAL



HDPE

KIT and KIT parts: These products are made from PE (Polyethylen). For disposal after use we encourage you to make sure that the KIT is either returned to the point of purchase for collection and shipment back to Excellent (for regeneration), or sorted according to the recommendations in your local area.



LDPE

Plastic bag: Recycled as clear PELD plastic.



PAP

Cardboard box: Recycled as cardboard.



PAPER

Brochure and instruction: Recycled as paper after end use.

