

RAMP KIT 3 CORNER

Height: 7,2 - 12,7 cm

Width: 75 cm

Depth: 75 cm

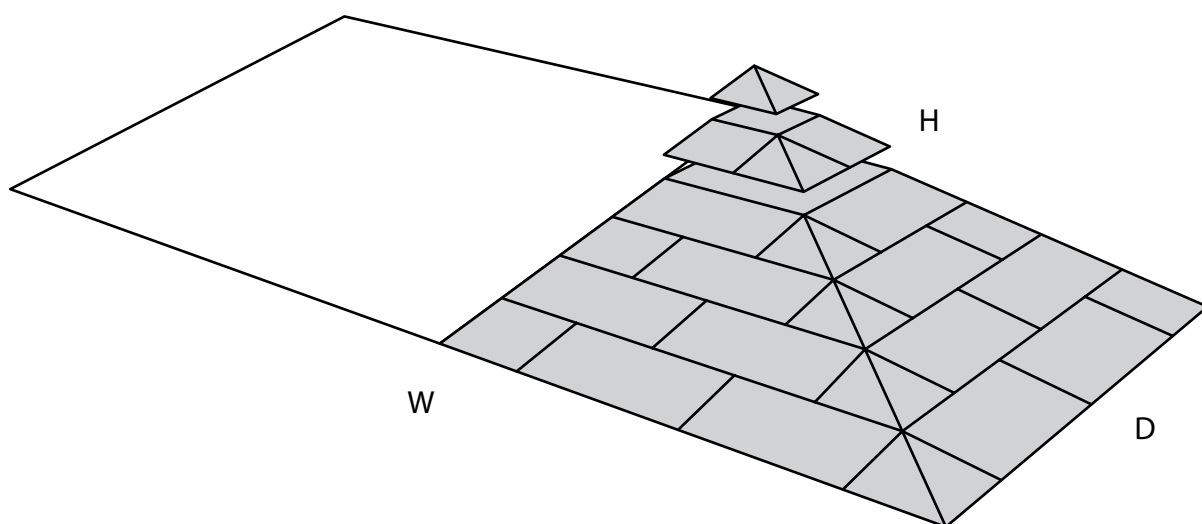

Included

15 x

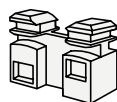

10 x



1 x

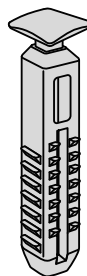

1 x

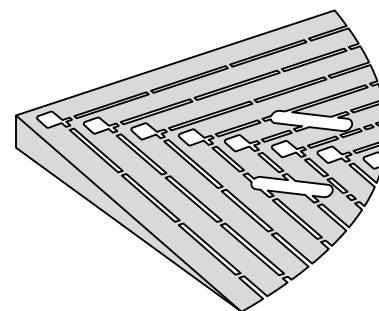

Danish Design Pat. Pend. and produced
in Denmark by Excellent Systems A/S



MOUNTING OF C-LOCKS ON THE RAMP

To connect a corner to a ramp, you have to mount c-locks in the ramp. If the ramp is already installed, you will have to remove the two upper layers.

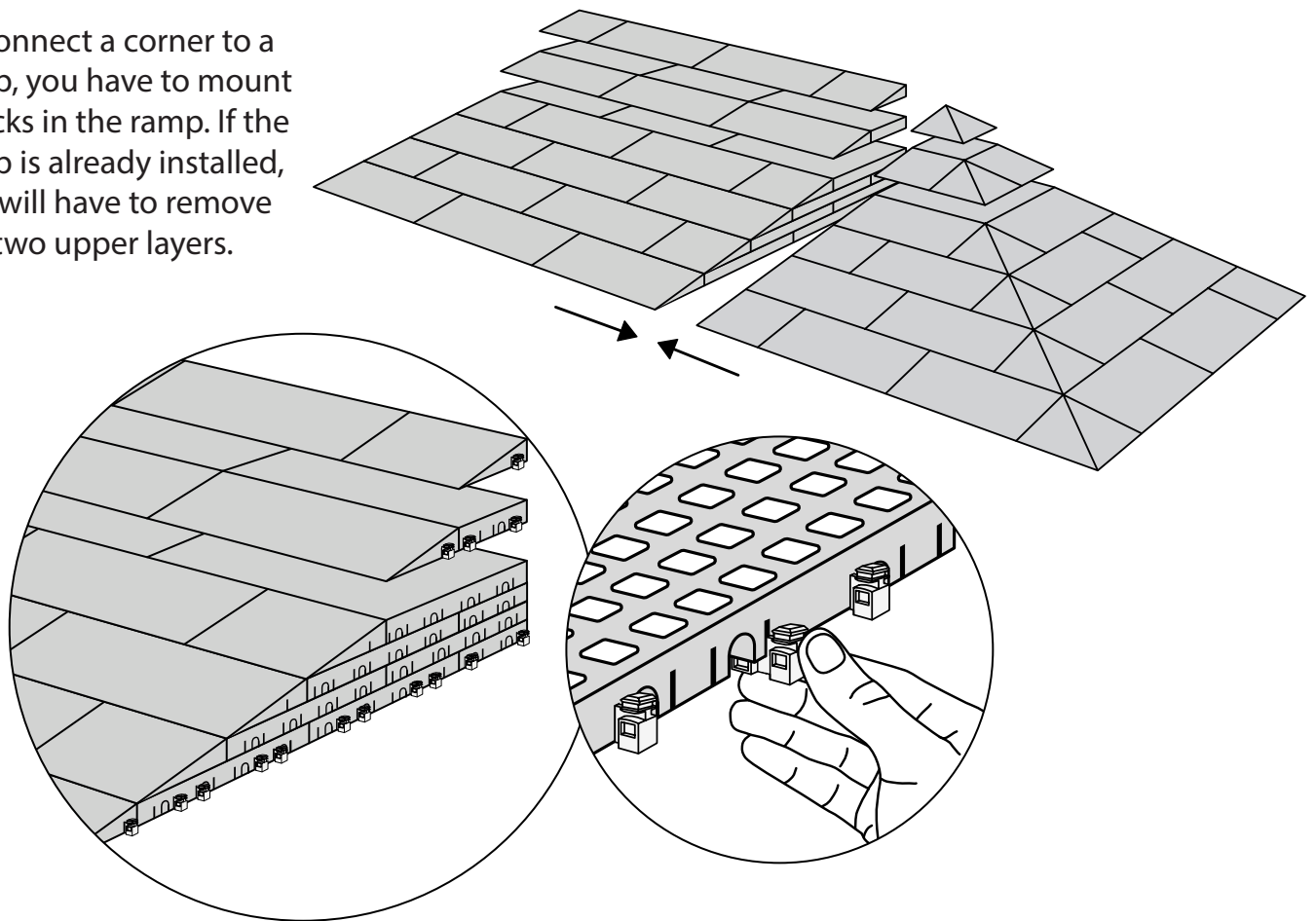

CORNER RAMP ADJUSTER

If Ramp Adjusters used/needed in the installation, be aware that the ramp and the corner gain the same height.

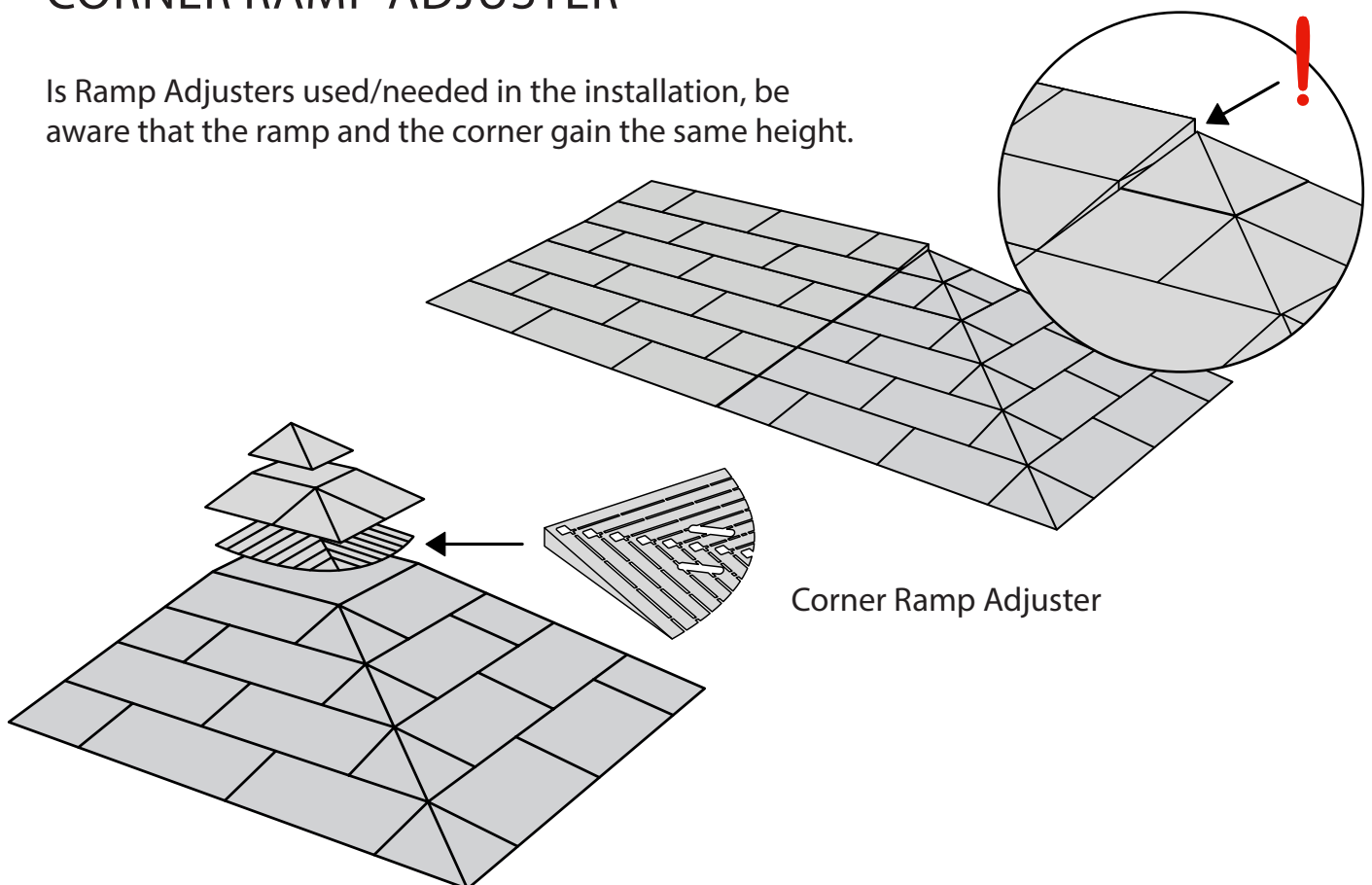

Corner Ramp Adjuster height adjustments:

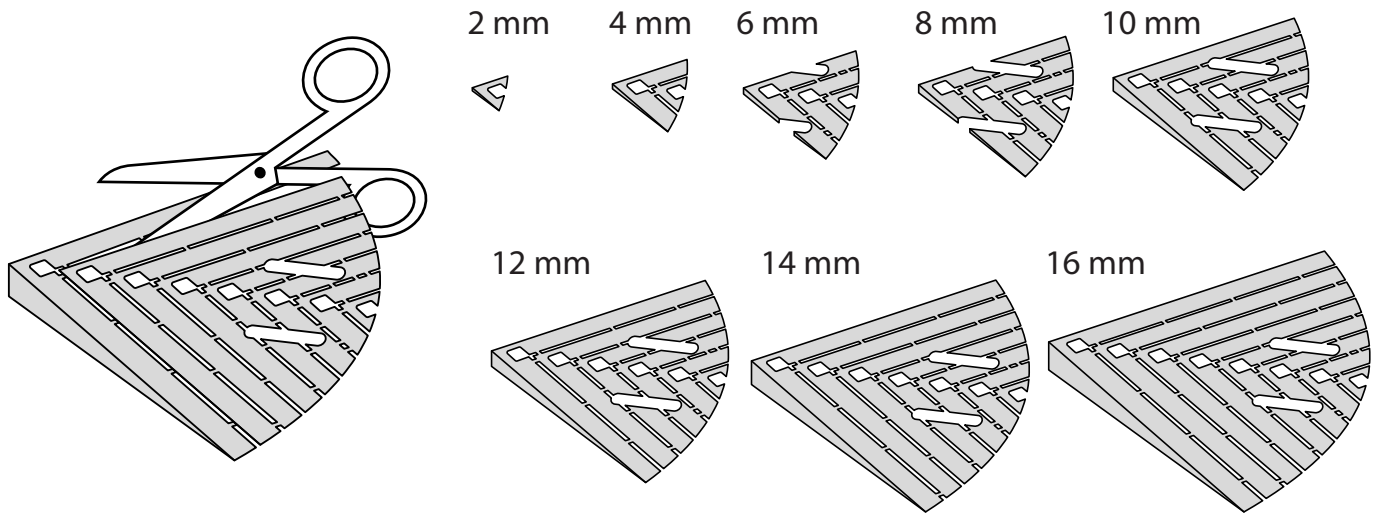

PLACEMENT OF LOCKS

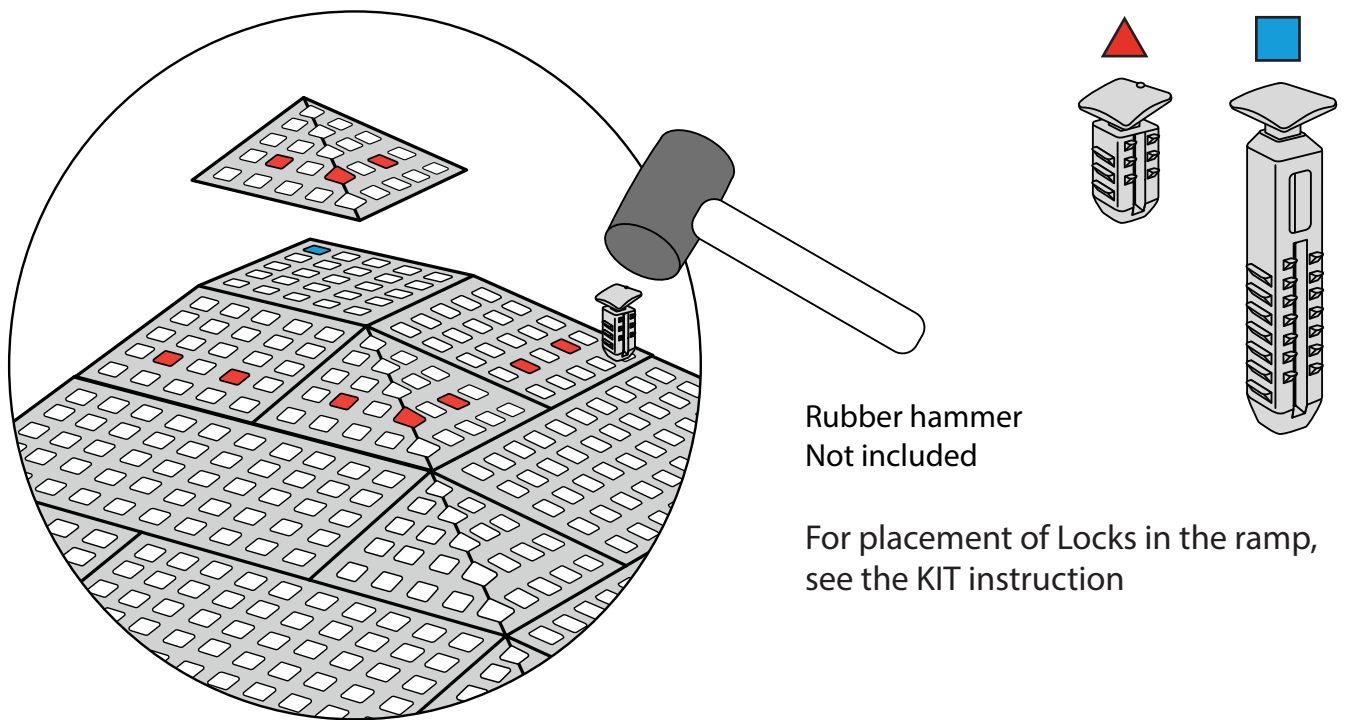

FASTENING WITH STOPPERS

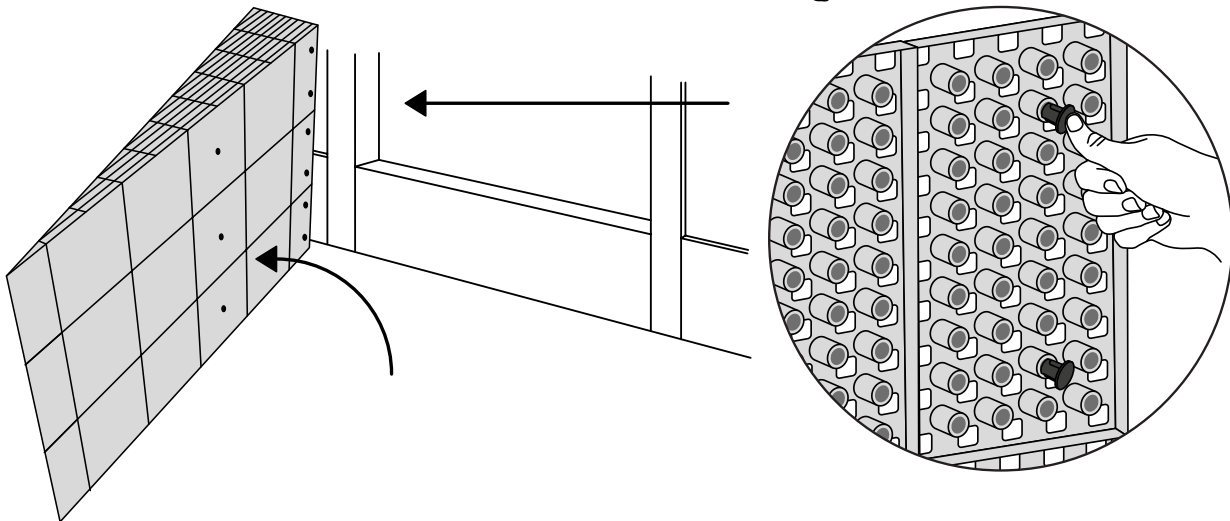

FASTENING WITH MOUNTING PADS

Same instruction as for Ramp KITS.

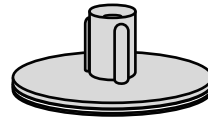

Indoor:

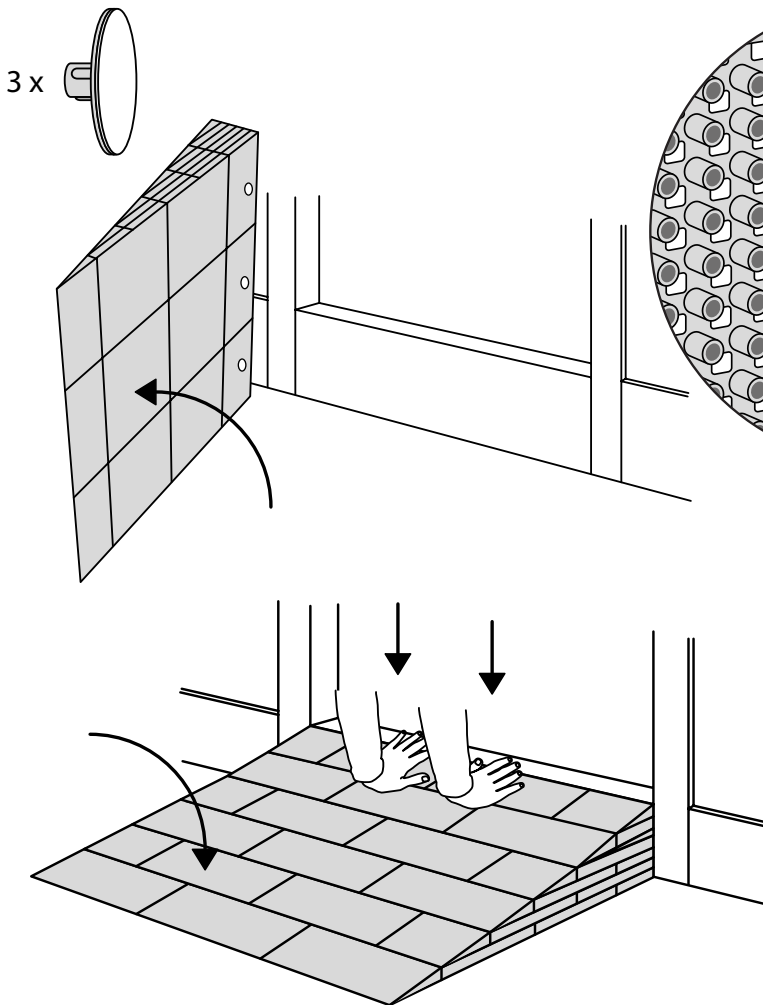

Outdoor:

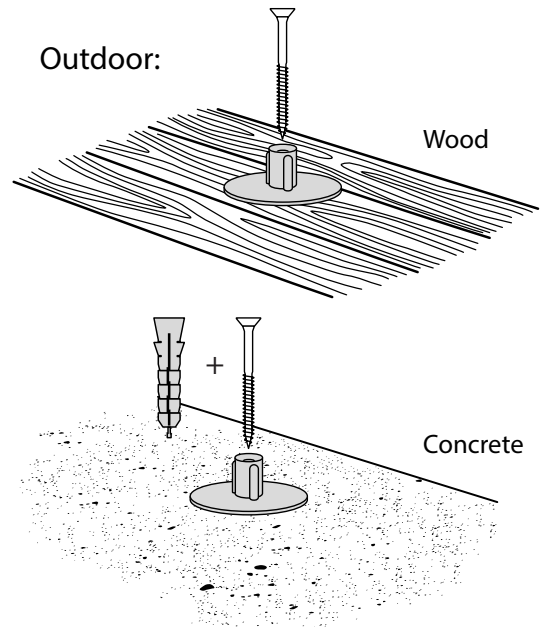

DISPOSAL



KIT and KIT parts: These products are made from PE (Polyethylen). For disposal after use we encourage you to make sure that the KIT is either returned to the point of purchase for collection and shipment back to Excellent (for regeneration), or sorted accordingly to the recommendations in your local area.



Plastic bag: Recycled as clear LDPE plastic.



Cardboard box: Recycled as cardboard.



Brochure and instruction: Recycled as paper after end use.

